

# Better practice guide for resource recovery in residential developments



© 2019 State of NSW and the NSW Environment Protection Authority

With the exception of photographs, the State of NSW and the NSW Environment Protection Authority (EPA) are pleased to allow this material to be reproduced in whole or in part for educational and non-commercial use, provided the meaning is unchanged and its source, publisher and authorship are acknowledged. Specific permission is required for the reproduction of photographs.

The EPA has compiled this guide in good faith, exercising all due care and attention. No representation is made about the accuracy, completeness or suitability of the information in this publication for any particular purpose. The EPA shall not be liable for any damage which may occur to any person or organisation taking action or not on the basis of this publication. Readers should seek appropriate advice when applying the information to their specific needs. This document may be subject to revision without notice and readers should ensure they are using the latest version.

All content in this publication is owned by the EPA and is protected by Crown Copyright, unless credited otherwise. It is licensed under the Creative Commons Attribution 4.0 International (CC BY 4.0), subject to the exemptions contained in the licence. The legal code for the licence is available at Creative Commons.

The EPA asserts the right to be attributed as author of the original material in the following manner: © State of New South Wales and the NSW Environment Protection Authority 2019.

Cover: One Central Park, Broadway, Sydney; Photo: Elton Consulting

Published by:

NSW Environment Protection Authority  
59 Goulburn Street, Sydney NSW 2000  
PO Box A290, Sydney South NSW 1232  
Phone: +61 2 9995 5000 (switchboard)  
Phone: 131 555 (NSW only – environment information and publications requests)  
Fax: +61 2 9995 5999  
TTY users: phone 133 677, then ask for 131 555  
Speak and listen users: phone 1300 555 727, then ask for 131 555  
Email: [info@epa.nsw.gov.au](mailto:info@epa.nsw.gov.au)  
Website: [www.epa.nsw.gov.au](http://www.epa.nsw.gov.au)

Report pollution and environmental incidents  
Environment Line: 131 555 (NSW only) or [info@epa.nsw.gov.au](mailto:info@epa.nsw.gov.au)  
See also [www.epa.nsw.gov.au](http://www.epa.nsw.gov.au)

ISBN 978 1 922260 48 2  
EPA 2019P1559  
April 2019

# Contents

<b>Contents</b>	<b>3</b>
<b>Glossary</b>	<b>6</b>
<b>Abbreviations</b>	<b>9</b>
<b>1. Introduction and purpose</b>	<b>10</b>
1.1. Purpose	10
1.2. Context	10
1.3. Who benefits from better practice	13
1.4. Waste and resource recovery design principles	13
1.5. How to use this guide	15
<b>2. Guidance for all developments and building types</b>	<b>16</b>
2.1. Introduction	16
2.2. The planning process	16
2.3. Council waste services	17
2.4. Use of private waste collection contractors	19
2.5. Improving resource recovery	20
2.6. Food waste and composting	21
2.7. Bin storage areas	22
2.8. Minimising amenity impacts through design	24
2.9. Ongoing management and maintenance	26
2.10. Work, health and safety	27
<b>3. Low-rise medium-density housing</b>	<b>29</b>
3.1. Defining low-rise medium-density housing	29
3.2. Key considerations	29
3.3. Waste management options	30
3.4. Bin storage areas	30
3.5. Collection points	35
3.6. Bin-carting routes	35
3.7. Bulky waste storage	35
<b>4. Residential flat buildings: low-rise</b>	<b>36</b>
4.1. Definition of residential flat buildings: low-rise	36
4.2. Key considerations	36
4.3. Waste management options	37
4.4. Bin storage areas	38
4.5. Temporary holding areas	39
4.6. Collection points	39
4.7. Bin pads	39

4.8. Bulky waste storage	40
<b>5. Residential flat buildings: medium-rise and high-rise</b>	<b>42</b>
5.1. Definition of residential flat buildings: medium-rise and high-rise	42
5.2. Key considerations	42
5.3. Waste management options	43
5.4. Temporary holding areas	47
5.5. Collection points	47
5.6. Bulky waste storage	47
5.7. Problem waste and other resource recovery	48
5.8. Supporting infrastructure	49
5.9. Access	50
5.10. Ongoing management	50
<b>6. Mixed-use developments</b>	<b>53</b>
6.1. Definition of a mixed-use development	53
6.2. Key considerations	53
6.3. Provision of services	54
6.4. Waste types and handling methods	54
6.5. Waste management options	55
6.6. Bin storage areas	56
6.7. Supporting infrastructure	57
6.8. Ongoing management	57
<b>7. New subdivisions and planned precincts</b>	<b>61</b>
7.1. Key considerations	61
7.2. Planning for access and waste collection	62
7.3. Waste management options	64
7.4. Onsite collection considerations	65
7.5. Kerbside collection point considerations	65
7.6. Bin storage areas	65
7.7. Bin pads	68
7.8. Innovative waste collection systems	69
7.9. Circular economy principles in new developments	71
<b>Appendices</b>	<b>72</b>
Appendix A: Waste management plan checklist	72
Appendix B: Collection services and vehicles	75
Collection services	75
Collection vehicles	80
Appendix C: Bin storage areas – location and design	82
Bin storage areas	82
Appendix D: Other waste collection technology	87
Automated waste collection systems	87

<b>Underground bins</b>	<b>88</b>
<b>Appendix E: Treatment and management of food waste</b>	<b>90</b>
<b>In-sink food waste disposer units</b>	<b>90</b>
<b>Onsite composting and worm-farming</b>	<b>91</b>
<b>Rapidly decomposed or dehydrated food waste</b>	<b>92</b>
<b>Macerators</b>	<b>93</b>
<b>Viability of the technology</b>	<b>93</b>
<b>Food waste in commercial premises</b>	<b>93</b>
<b>Appendix F Waste and recycling generation rates</b>	<b>94</b>
<b>Allocated domestic waste and recycling generation capacities</b>	<b>94</b>
<b>Estimated domestic waste and recycling generation rates</b>	<b>94</b>
<b>Estimated commercial waste and recycling generation rates</b>	<b>95</b>
<b>Appendix G: Waste management equipment and bins</b>	<b>98</b>
<b>Mobile bins</b>	<b>98</b>
<b>Chute systems</b>	<b>101</b>
<b>Automatic carousel bin systems</b>	<b>107</b>
<b>Waste compactors</b>	<b>107</b>
<b>Appendix H: Vehicle access and turning circles</b>	<b>110</b>
<b>General</b>	<b>110</b>
<b>Road and driveway construction and geometry</b>	<b>110</b>
<b>Collection from basements</b>	<b>110</b>
<b>Vehicle turning circles</b>	<b>110</b>
<b>Turntables</b>	<b>111</b>
<b>Appendix I: Standard signage</b>	<b>112</b>
<b>Waste signs</b>	<b>112</b>
<b>Problem waste signs</b>	<b>113</b>
<b>Safety signs</b>	<b>113</b>

## Glossary

attached dwelling	As defined in the <u>Standard Instrument LEP</u> , a building containing three or more dwellings where: (a) each dwelling is attached to another dwelling by a common or party wall, and (b) each of the dwellings is on its own lot of land and (c) none of the dwellings are located above any part of another dwelling. BCA equivalent: Class 1
battle-axe lots	Lots that have an access corridor or a right-of-carrageway over another lot. These lots are usually designed to resolve residual land issues, access denied streets or lots that front onto public open space.
bin-carting route	Travel route for transferring bins from the storage area to a nominated collection point.
bulk bins	Containers designed for the storage of waste, recycling and other waste with capacity of 660L or greater. Bulk bins are usually fitted with wheels for manoeuvrability.
bulky waste services	Services to manage bulky household waste, such as appliances, furniture, branches and other oversized items. Also referred to as 'clean-ups' or 'hard waste'.
collection point	The point from which waste or recycling is collected and transferred to the collection vehicle.
Development control plan (DCP)	A Development Control Plan (DCP) provides detailed planning and design guidelines to support the planning controls in the Local Environmental Plan (LEP). It identifies additional controls and standards for addressing development issues at a local level.
dual occupancy (attached)	As defined in the <u>Standard Instrument LEP</u> , two dwellings on one lot of land that are attached to each other. This does not include a secondary dwelling.
dual occupancy (detached)	As defined in the <u>Standard Instrument LEP</u> , two dwellings on one lot of land that are detached from each other. This does not include a secondary dwelling.
dwelling house	As defined in the <u>Standard Instrument LEP</u> , a building containing only one dwelling.
greenfield site	A site on which no development has previously taken place.
habitable unit	In this guide, used to refer to an individual dwelling unit within a residential flat building or other multi-unit dwelling.
indemnity	Security or protection against a loss or other financial burden.
kerbside collection	A service whereby waste and recycling are collected from the kerbside.
layback	A section of the kerb which is modified to allow access of vehicles. The layback forms part of the vehicle crossover. Councils have standards and construction requirements for layback and vehicle crossovers.

Local Environmental Plan (LEP)	Local Environmental Plans (LEPs) guide planning decisions for local government areas. They do this through zoning and development controls, which provide a framework for the way land can be used.
manor house	<p>As defined in the Standard Instrument LEP, a building containing three or four dwellings, where:</p> <ul style="list-style-type: none"> <li>• each dwelling is attached to another dwelling by a common wall or floor</li> <li>• at least one dwelling is partially or wholly located above another dwelling</li> <li>• the building contains no more than two storeys (excluding any basement)</li> </ul> <p>Manor houses are a type of residential flat building. The BCA equivalent is Class 2.</p>
mixed-use development	<p>As defined in the <u>Standard Instrument LEP</u>, a building comprising two or more different land uses.</p> <p><b>BCA equivalents:</b> Class 4, Class 5, Class 6, Class 7, Class 8, Class 9.</p>
mobile bin	A bin with wheels that can be moved around. Also, colloquially referred to as 'wheelie bins'.
multi-dwelling housing	<p>As defined in the <u>Standard Instrument LEP</u> (from 6 July 2018), multi dwelling-housing means three or more dwellings (whether attached or detached) on one lot of land where:</p> <p>(a) each dwelling has access at ground level, and</p> <p>(b) no part of a dwelling is above any part of any other dwelling,</p> <p>and includes multi-dwelling housing (terraces).</p>
multi-dwelling housing (terrace)	As defined in the <u>Standard Instrument LEP</u> (from 6 July 2018), terrace means multi-dwelling housing where all dwellings are attached, and are generally aligned along one or more public roads.
multi-unit dwelling (MUD)	In this guide, the term is used to refer to residential development of more than one dwelling. This ranges from dual occupancies and attached dwellings to high-rise residential flat buildings.
onsite collection	When the collection vehicle enters the property and services the development within the property boundary from a designated loading area.
organics services	Services and facilities to manage garden and food organics, which may include bin-based or bulk collection systems or onsite composting.
Owners corporation	An organisation or group of persons that is identified by a particular name and that acts, or may act, as an entity.
Planned Precincts	Areas that the Minister for Planning considers have a wider social, economic or environmental significance for the community or have redevelopment potential on a scale that is important in implementing the state's planning objectives. Planned Precincts are envisaged as larger areas, usually made up of multiple land holdings, capable of delivering significant additional growth and requiring coordination from state and local government to realise their potential.

positive covenant	Created under either section 88 of the <i>Conveyancing Act 1919</i> , the covenant imposes an obligation on the new owner of the land. For example, maintenance of access to bin storage areas.
recycling services	Services and facilities to manage dry recyclable materials, such as paper, cardboard, glass, steel, aluminium and plastic. The range of recyclables collected as part of any recycling service may vary between council areas. Recyclables may be collected commingled, that is all materials mixed together, or as separate streams.
residential flat building (RFB)	As defined in the <u>Standard Instrument LEP</u> , a building containing three or more dwellings on one lot of land, but does not include an attached dwelling or multi-dwelling housing. <b>BCA equivalent:</b> Class 2. Note that developments of four or more storeys require lifts.
residential flat building: low-rise	In this guide, residential flat buildings of two to four storeys.
residential flat building: medium-rise	In this guide, residential flat buildings of four to seven storeys.
residential flat building: high-rise	In this guide, residential flat buildings of more than seven storeys.
residual waste	The remaining portion of a waste stream after other materials have been separated or extracted for processing, recovery or recycling.
route of travel	The travel path for a waste collection vehicle when entering the site to access the nominated collection point.
state environmental planning policy (SEPP)	A planning instrument that deals with matters of state or regional environmental planning significance.
temporary holding area	An area where bins are transferred and stored awaiting collection. Bins are usually transferred back to the bin storage area as soon as possible after collection occurs. This bin transfer is generally undertaken by a caretaker.
urban infill	Development that is sited on vacant or under-used land within an existing urban area that is already largely developed.
vehicle crossover	The constructed portion of the nature strip that provides vehicular access from the edge of the road to the property boundary.
waste and recycling services	Services and facilities to manage residual domestic and/or commercial waste and recycling, including food and garden organics.
waste management plan	A document that outlines how waste will be managed for a proposed development. Waste management plans are often divided into sections for demolition construction and ongoing use of a development. Requirements for waste management plans may vary between local government areas.
waste storage area	An area which stores all allocated bins and waste storage for the development. Can be a nominated individual or communal storage area.



wheel-in and wheel-out service

A type of waste collection service offered by local councils where the council waste collection personnel enter the premises to collect the bins and returns them to the property. Can also be referred to as 'collect and return' service.

## Abbreviations

BCA	Building Code of Australia
DA	Development Application
DPE	NSW Department of Planning and Environment
EPA	NSW Environment Protection Authority
LEP	Local Environmental Plan
MUD	Multi-unit dwelling
RFB	Residential Flat Building
WHS	Work health and safety

# 1. Introduction and purpose

## 1.1. Purpose

This guide is a tool to assist local council planners, architects, urban designers, developers, building designers and other professionals to incorporate better practice in the design, establishment, operation and ongoing management of waste and recycling services in residential developments. It is intended for use when designing new residential developments as well as undertaking major refurbishments or renovations of existing premises.

The objectives of this guide are to:

- raise awareness that waste and recycling collection systems are essential services that must be properly designed for
- recognise the need to plan and design waste and recycling systems early in the building development process
- provide guidance on how to make the collection of waste and recycling convenient and safe for occupants and waste collection personnel
- provide guidance on how to improve the performance of waste and recycling collection systems
- minimise impacts on the visual or other amenity of the building or neighbourhood.

This guide sets out what better practice looks like to help achieve good waste management outcomes, while encouraging safe, easy and convenient services that preserve the reputation and amenity of the development. To ensure better practice outcomes, this guide encourages early consultation with councils regarding specific council waste management requirements. In the case of large, complex developments, discussions with the council's waste management department about appropriate waste management systems are strongly recommended prior to lodgement of the DA.

This guide does not cover waste management requirements for developments that consist solely of commercial, retail and/or industrial premises. For information on these building types, refer to the EPA's *Better practice guidelines for waste management and recycling in commercial facilities* (2012)<sup>1</sup>.

## 1.2. Context

### Population growth and new housing supply

Projections show that the NSW population will grow to 9.9 million by 2036, with much of this within the Greater Sydney Region. It is estimated that an extra 900,000 new dwellings will be needed by 2036<sup>2</sup> in the Sydney metropolitan area alone, to accommodate the increased number of households.

In metropolitan Sydney and regional centres, the percentage of households living in apartments is also increasing year on year. Apartments now account for 28% of total occupied private dwellings in Greater Sydney, representing a 16% increase between the 2011 and 2016 censuses. As the demand for high- and medium-density living increases, there is an associated need to ensure that these dwelling types contain better practice waste and resource recovery systems.

---

<sup>1</sup> [www.epa.nsw.gov.au/-/media/epa/corporate-site/resources/managewaste/120960-comm-ind.pdf](http://www.epa.nsw.gov.au/-/media/epa/corporate-site/resources/managewaste/120960-comm-ind.pdf)

<sup>2</sup> NSW Planning and Environment [www.planning.nsw.gov.au/Research-and-Demography/Demography/Population-Projections](http://www.planning.nsw.gov.au/Research-and-Demography/Demography/Population-Projections).

## Waste and resource recovery targets

The NSW Government has a clear waste and resource recovery agenda. Its *Waste and Resource Recovery Strategy 2014–21* sets the targets for diverting waste from landfill.<sup>3</sup> In February 2019, the EPA released its *Circular Economy Policy* which provides a future where we change the way we produce, assemble, sell and use products to minimise waste and reduce our impact on the environment. A circular economy is all about valuing our resources by getting as much use out of products and materials as possible and reducing the amount of waste we generate.

Residential flat buildings (RFB) provide a high volume of materials that have the potential to be recovered. To enable a circular economy, residents need to have access to effective resource recovery systems.

To help meet waste diversion targets, it is crucial that effective resource recovery systems are carefully designed upfront in new residential buildings. These systems should provide the best opportunity for building occupants to recycle correctly, recover resources and minimise waste sent to landfill.

Though difficult to quantify accurately, local government has reported that some multi-unit dwellings (MUDs) do not have adequate facilities to support recycling and waste minimisation. This guide seeks to identify effective guidelines and solutions to support resource recovery and waste minimisation in MUDs.

## Achieving healthy, safe and liveable communities

In addition to achieving waste and resource recovery targets, better practice waste management systems can help to maintain a development's visual and physical amenity.

Facilities for the proper storage and collection of waste, recycling and organics are essential, but are sometimes overlooked or undervalued. Appropriate design and management will encourage residents to use the systems correctly. Where designed or managed poorly, they are a perpetual irritation, which can become worse as the building ages.

Poor design can lead to:

- **large numbers of bins at the kerbside** for collection, causing difficulties for pedestrian access and traffic congestion during collection times. It can also affect building aesthetics and local area amenity.



Bins serviced from the kerbside reducing public amenity and causing traffic hazards

<sup>3</sup> [www.epa.nsw.gov.au/wastestrategy/warr.htm](http://www.epa.nsw.gov.au/wastestrategy/warr.htm)

- **illegally dumped waste** outside residential buildings due to inadequate storage space onsite for bulky waste awaiting collection



Illegally dumped material outside a residential flat building (Photo: Elton Consulting)

- **missed waste collection services** from difficult to service situations, such as parked cars preventing waste collection vehicles accessing laneways to service bins.











Parked cars blocking bin access (Photo: Peta Golla)

### 1.3. Who benefits from better practice

Better practice waste management planning in the design stage can make it easier and more convenient for residents, building managers and collection staff throughout the life of a development. **Table 1** shows how better waste management benefits a wide range of stakeholders.

Figure 1 Stakeholder and community benefits of better waste management practices

Stakeholder	Benefits
 <b>Architects/designers</b>	<ul style="list-style-type: none"> <li>• Recognition of good building design, leading to environmental and design awards and achievements</li> <li>• Compliance with council requirements</li> <li>• Faster and more efficient development approval</li> </ul>
 <b>Developers</b>	<ul style="list-style-type: none"> <li>• Improved reputation through increased satisfaction of buyers and building managers</li> <li>• Compliance with council requirements</li> <li>• Faster and more efficient development approvals</li> </ul>
 <b>Council and private certifiers</b>	<ul style="list-style-type: none"> <li>• Speedy and efficient approval of developments</li> <li>• Safe, clean and effective waste and recycling service delivery</li> <li>• Fewer complaints by cleaners, staff, tenants, visitors, owners and residents</li> </ul>
 <b>Agents/building managers</b>	<ul style="list-style-type: none"> <li>• Increased ability to maintain waste areas and equipment</li> <li>• Reduced risk of injury to cleaners, staff, tenants, visitors and residents</li> <li>• Fewer complaints by cleaners, staff, tenants, visitors, owners and residents</li> <li>• Reduced cost of maintenance and ongoing management</li> </ul>
 <b>Residents</b>	<ul style="list-style-type: none"> <li>• Greater satisfaction with service provision</li> <li>• Increased ability and willingness to participate in recycling</li> <li>• Improved amenity and safety</li> <li>• More cost-effective waste management systems</li> </ul>
 <b>Waste collection service providers</b>	<ul style="list-style-type: none"> <li>• Improved safety outcomes</li> <li>• Easier and more efficient collection</li> </ul>
 <b>Wider community</b>	<ul style="list-style-type: none"> <li>• Improved aesthetics, amenity, public health and safety</li> <li>• Reduced costs associated with litter and illegal dumping</li> <li>• Increase recovery of recycling and organics</li> </ul>
 <b>Wider environment</b>	<ul style="list-style-type: none"> <li>• Increased recovery of recyclables</li> <li>• Greater contribution to the state-wide targets for waste reduction and resource recovery</li> <li>• Cleaner streets and reduced litter in the environment</li> </ul>

### 1.4. Waste and resource recovery design principles

The following principles and objectives underpin the planning and design of waste and resource recovery systems in new residential developments.

#### DESIGN OBJECTIVE 1: Environmental sustainability and best practice

Developments meet requirements for long-term sustainability and best practice when:

- systems are designed to maximise waste separation and resource recovery
- innovative and best practice waste management collection systems and technologies are supported where appropriate
- flexibility in design allows for future changes in waste generation rates, materials collected and methods of collection

## **DESIGN OBJECTIVE 2: Effective waste and resource management**

Developments achieve effective waste and resource management when:

- waste services can occur in a safe, seamless and timely manner
- access to waste disposal and resource recovery services are safe and convenient for all residents
- functional and adequate storage spaces are provided for all waste and recycling streams, including temporary storage areas for bulky materials like cardboard boxes and oversized household waste.

## **DESIGN OBJECTIVE 3: Clean, safe and healthy living environments**

Developments protect and enhance the quality of life for the community when:

- negative impacts on amenity for residents, neighbours and the public, such as visually unpleasant waste storage areas, bad odours and noise from waste collection are minimised
- illegal dumping and litter from bins are minimised through good planning and installation of adequate storage and waste recovery infrastructure
- safe and easy access to waste and resource recovery storage areas is provided for residents, building managers and collection contractors.

## **DESIGN OBJECTIVE 4: Affordability**

Developments allow residents to engage in cost-effective waste services when:

- careful design and construction prevents costly retrofits
- flexibility in design allows for the collection of all waste and recycling streams to be cost-effective for residents.

## 1.5. How to use this guide

This guide has been specifically developed to assist architects, building designers and developers to effectively plan and design appropriate waste, recycling and organics management systems and facilities for residential developments.

The guide contains:

### **SECTION 2: Guidance for all developments and building types**

All readers are encouraged to read this section, which contains information that is relevant to all development types.

### **SECTIONS 3-7: Guidance for specific development types**

These sections are divided by development type and are intended to be read together with section 2.

### **APPENDICES**

The appendices provide further detailed and technical information.

Additional tools and resources, including case studies for different development types, are available on the EPA's website at [www.epa.nsw.gov.au/](http://www.epa.nsw.gov.au/).

### **Disclaimer**

This document is a guide only and has no legal force. It does not override state and local planning control requirements. The principles and objectives of this guide should be read alongside all other applicable codes and policies or plans, in particular:

- the *Apartment Design Guide 2015*
- *Low Rise Medium Density Housing Code 2017*
- individual council LEPs and DCPs relevant to the development location
- Work Health & Safety legislation.

## 2. Guidance for all developments and building types

### 2.1. Introduction

This section discusses essential issues and considerations for designing waste management systems that are common to all development types. It should be read in conjunction with the following sections relating to specific building types: **Sections 3-7**. **Appendix A** is a waste management plan checklist. Use it to help guide all necessary considerations to support better practice waste and resource recovery facilities.

### 2.2. The planning process

Many stakeholders are involved in the planning and delivery of waste management services. **Figure 1** gives an overview of the roles and responsibilities of key stakeholders in the planning of waste and resource recovery systems.



Figure 2 Getting it right – who’s responsible?

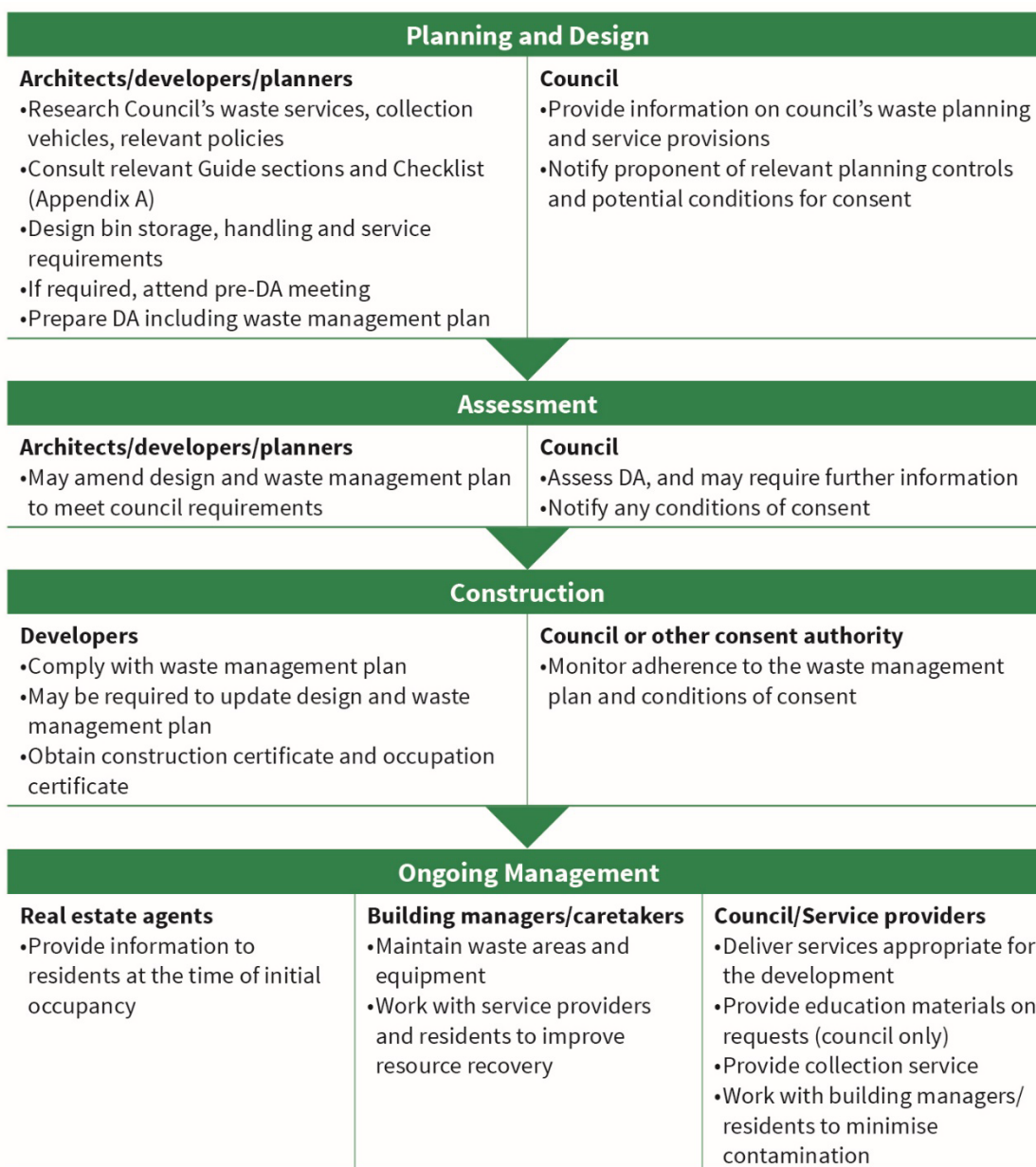

### 2.3. Council waste services

Waste services differ between local councils as they depend on contract arrangements, councils’ waste management strategies and policies, the population size and access to service provision.

Section 496 of the *Local Government Act 1993* requires councils to levy an annual domestic waste management charge for the provision of a waste management service on each parcel of rateable land. This charge applies even if councils do not provide a waste service.

Local councils operate waste and recycling collection services in two ways:

- by contracting their waste and recycling services to a private waste collection operator, or
- in-house by using the council’s own labour and vehicles.

How councils choose to run their waste, recycling and organics services has an impact on the type of services they offer, the type of bins supplied to residents and the range of vehicles within their fleet. For example, some councils may not have a waste collection vehicle within their fleet to service bulk bins.

## Collection services

Councils offer a range of waste and recycling collection services but not all councils provide all service types. The range of services include:

- **Kerbside collection:** waste, recycling and organics are collected from the kerbside
- **Wheel-in and wheel-out service (also known as ‘collect and return’):** council waste collection personnel enter the premises to collect the bins and return them to the property
- **Onsite collection:** collection occurs within a development site’s boundary at a nominated area.

Refer to **Appendix B** for further information about collection services.

## Collection point

The collection point is the point from which waste or recycling is collected and transferred from the storage container to a collection vehicle.



Good practice example of clearly defined waste service collection points for bin (Photo: Penrith City Council)

The location of the collection point must be decided in consultation with the local council and needs to be identified early in the design process as it can have building design implications. It can also determine the ability of council to provide the service.

## Bin types

The type of waste management services that can be provided to individual developments will vary according to a council’s service and the specifications of the waste collection vehicles. For example, some councils can service bulk bins (660L or 1100L) while others can only service 240L mobile bins. The standard waste, recycling and organics bins for single dwelling households and some types of low-rise medium-density housing are pictured below.



Colour-coded bins for garbage, commingled recycling and garden organics or combined food and garden organics.

Colour coding bin lids helps people recognise which materials belong in each bin. Consistent colour coding of bin lids by all councils helps educate residents on how to use the waste and recycling services correctly. The above bin lids are colour-coded for garbage (red), commingled recycling (yellow) and garden organics or combined food and garden organics (green).

The table below outlines the range of bin volume specifications that may be used for council waste services across most development types.

Table 1 Commonly used bin types and sizes provided by local councils

Stream	Common single dwelling bin sizes	Common residential flat building bin sizes	Common bin or lid colour coding
Garbage	80L, 120L, 240L	240L, 660L, 1100L	Red
Commingled recyclables*	120L, 240L	240L, 660L, 1100L	Yellow
Recyclable paper and cardboard	120L, 240L	240L, 660L, 1100L	Blue
Garden organics	240L**	240L	Lime green
Food and garden organics	240L	240L	Lime green
Food only**	Not common	240L	Maroon

\* Plastics, glass bottles and jars, aluminium cans, paper and cardboard mixed together

\*\* Food only services are being trialled by some councils in NSW, but availability of the service is currently not widespread. Check with councils for any future plans to introduce this service.

Refer to **Appendix G** for further detail about waste bins and containers.

## 2.4. Use of private waste collection contractors

The waste management systems and the location of the collection point should always be designed so that the council can provide the standard domestic waste management service for the life of the building. Some councils do not allow private contractors to service residential dwellings.

Some councils may require that as part of the waste management plan submitted with the DA, the following provisions are met:

1. a statement from a waste management provider is submitted stating the proposed system is able to be serviced by a private contractor, and
2. the waste management plan states the reason why a private waste collection contractor is required for the building and information supporting this decision.

If a private contractor is planned, the relevant council may still require that the design of the waste storage area comply with its specifications. This is because if, for any reason, the use of a private

contractor stops, the council may be called on to carry out the waste collection. If this happens, council will be required to service the bins using its own collection vehicles or those of its contractor.

If a private contractor is used, council is still required to levy an annual charge for domestic waste services to each residential premise. This fee will have to be paid to council by the owner of each dwelling, even if the waste service is not provided by the council. This will be in addition to the waste service fee charged by the private contractor.

Where a private collection contractor is the best option, an agreement should be put in place between the strata manager or body corporate, and council requiring the waste collection contractor supply quarterly, or by some other regular interval, waste and recycling data reports to council. This data will help the council to monitor the performance of the waste and recycling systems, assess contamination rates and provide any necessary education materials to the residents of the building.

## 2.5. Improving resource recovery

### Design of waste systems

Waste management systems must be convenient and simple to use. Effective systems encourage proper use, reduce illegal dumping, maintain cleanliness and amenity of the building and its surrounds and reduce contamination.

Contamination occurs when the incorrect items are placed in the wrong bin. High levels of contamination in recycling or organic bins are likely to result in materials being rejected at the recycling facility and ending up in landfill.

Methods to encourage resource recovery and minimise contamination include:

- locating recycling and organics bins adjacent to waste bins
- providing adequate storage space within each dwelling for sorting materials ready for disposal into the correct bin
- providing separate bins for each dwelling, marked with the unit number to encourage ownership of bins
- displaying information signs in common areas clearly identifying waste, recycling and organics bins and storage areas
- using standard and consistent signage and colour coding (refer **Table 1**) that provides instruction on how to use each bin correctly
- through a body corporate or building manager, initiating contact with the council before the building is occupied to ensure the service is ready and to identify resources to assist with educating residents
- having enough space to allow flexibility in services including space for additional recycling options – for example an organics bin or e-waste collection

Each of these methods are further detailed in the guide. There is also a variety of education resources to support improved waste management and resource recovery available through the EPA or the local council. Ongoing education is one of the most important factors in encouraging residents to correctly use waste management systems.

### Educating the community and residents

The transient nature of people living in residential flat buildings (RFBs), and differences between buildings and services offered by councils, makes ongoing education critical to proper use of waste systems.

Waste education and communication is a specialised area and care must be taken to ensure waste and recycling messages and the mediums of communication are consistent with the policies of local council and NSW Government.

Council waste education officers can assist in providing advice and resources to establish and improve education and communication programs, such as:

- standard signage and stickers for buildings and bins

- correctly colour-coded bin lids
- materials in various languages to assist culturally and linguistically diverse residents to use the waste system.

## Role of building managers and cleaners

Building managers, facilities managers, strata managers, executive committees and cleaning staff can all play a key role in the success of waste management systems.

The strata manager or body corporate can designate the building manager or cleaning staff to support better use of waste and recycling services and systems. They can also ensure accurate waste information is provided to residents. To ensure this happens it is important that:

- the strata manager or body corporate provides the designated building manager or cleaning staff contact details to council's waste management department when the building is first occupied and maintains these contact details
- the building manager or cleaning staff provides information to new residents on how to use the waste management systems, such as the council's clean-up service procedure and which materials go in which bin or should be taken to alternate waste management facilities e.g. paint and batteries (some councils may have information packs that building managers can hand out as needed)
- the strata manager or body corporate remain informed of the council's waste management services and systems so that the building manager or cleaning staff can update residents as needed

The strata manager or body corporate can identify a **building champion** to take responsibility for maintaining the waste and recycling system. Building champions could be paid cleaners, facilities managers or even residents. Their support, time and effort in keeping waste and recycling rooms clean and informing residents about how to use the waste, recycling and organics services can be critical.

Council's waste management personnel should be advised of the building champion's contact details so that council can support them.

## 2.6. Food waste and composting

In NSW, approximately 70% of households have access to garden waste services and an increasing proportion of councils also offer combined food and garden services. Where these are not currently available, onsite composting and worm farms are good ways to help residents recycle some of their food scraps. They also provide residents an opportunity to connect in outdoor open spaces within their property.

Communal composting and worm farms can work effectively where:

- a caretaker or gardener is able to manage them
- there are landscaped areas or communal gardens for them
- they can be easily incorporated into the design of communal open space areas
- impacts from odour, vermin and insects are not likely to affect residents.

Communal food waste systems should be visible and easily accessible by residents to assist in keeping the area well maintained.

Refer to **Appendix E** for further information on treatment and management of food waste.



Compost bin and worm farm (Photo: Doug Beckers)

## 2.7. Bin storage areas

It is essential to consider bin storage areas early in the design process so that they can be successfully integrated into the overall design of the development and are convenient for all users.

The general guiding principle for bin storage areas is to ensure that enough space is provided within the property boundary to store the range of bins for the quantity of waste, recycling and organics (and other materials where appropriate) likely to be generated between collections. It is also recommended that residents should not be required to walk **more than a maximum distance of 30m** to access the bin storage area.

**Figure 3** illustrates the main steps in planning for bin storage areas.

**Figure 3** Checklist for bin storage areas

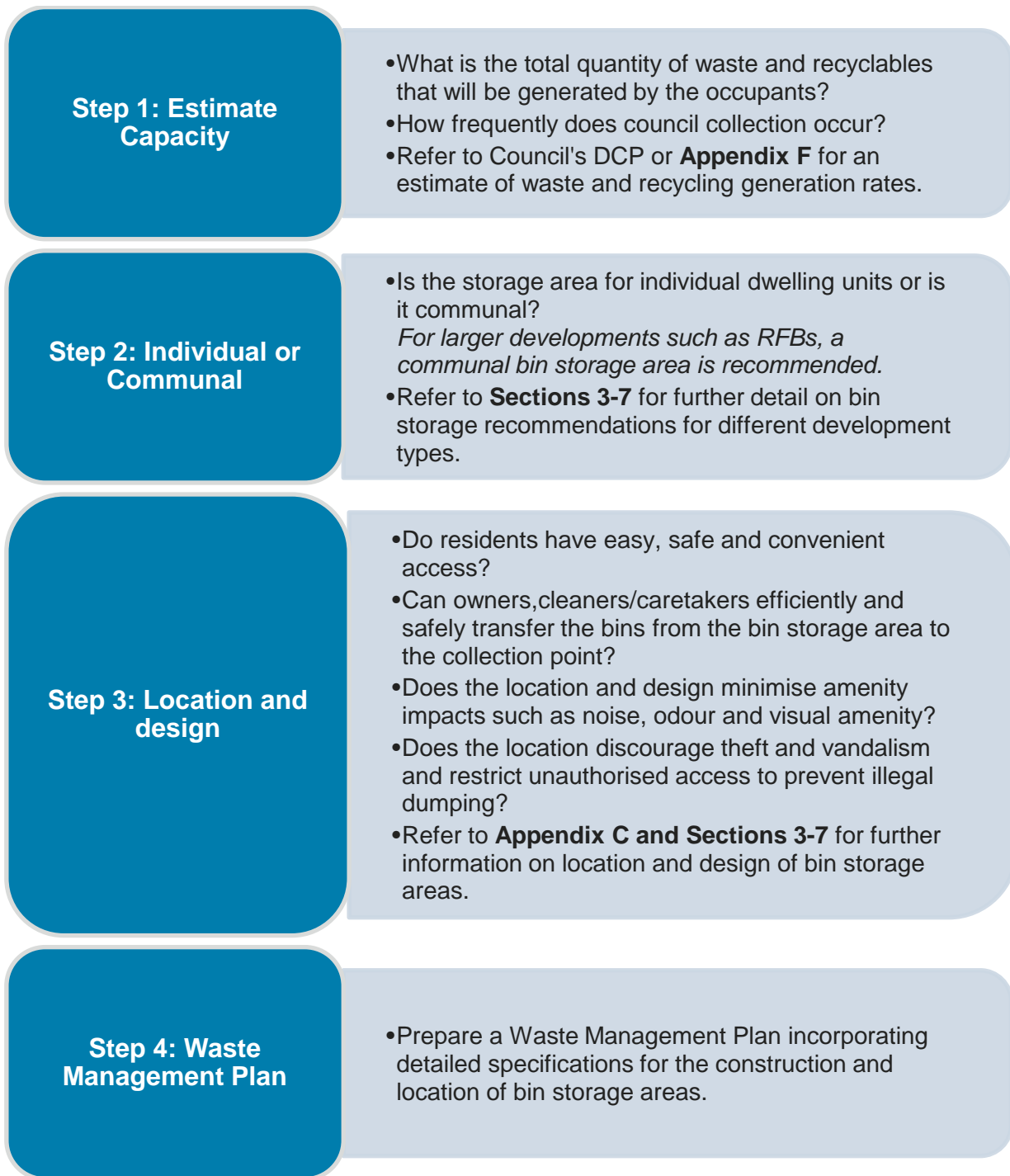
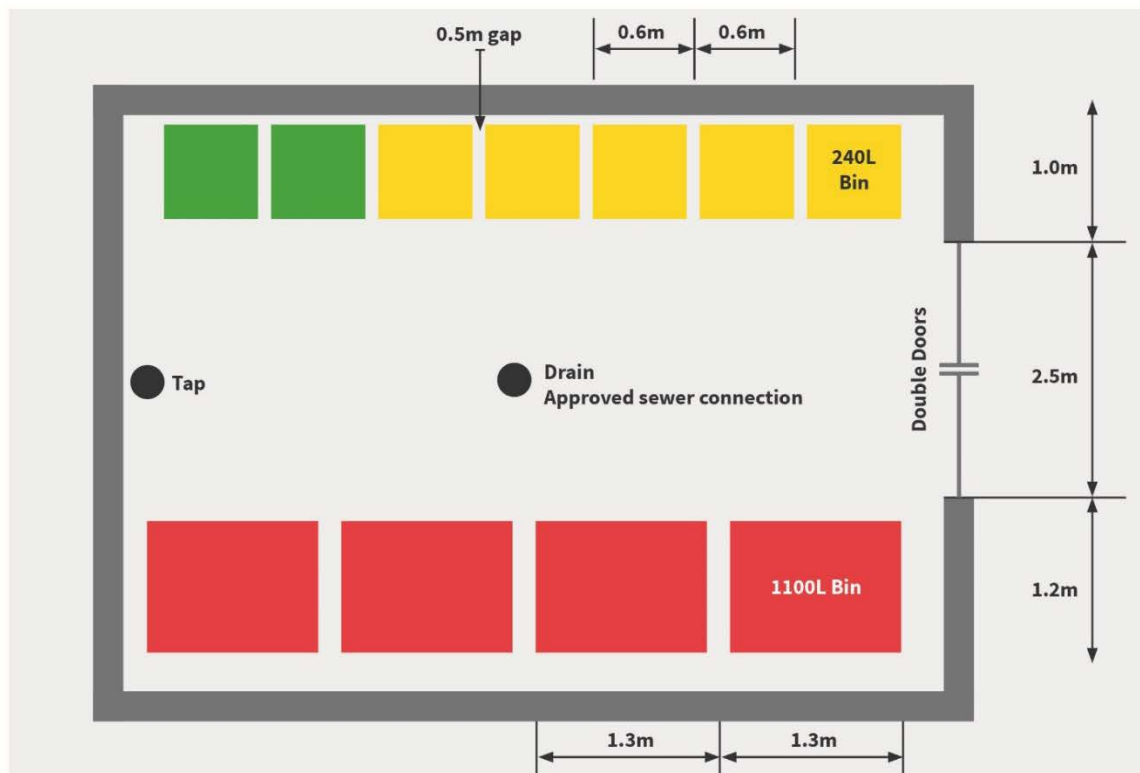

Figure 4 Typical bin storage room with mix of mobile bins and bulk bins



## 2.8. Minimising amenity impacts through design

### Noise

Local councils and the EPA often receive complaints from residents about noise from waste and recycling collections. Noise issues are becoming more common with the increase in higher density living and more mixed-use developments. The servicing needs of businesses in mixed-use developments are different from residential dwellings; for example business waste collections may need to be carried out late in the evening.

Noise cannot be eliminated, but it can be better managed through intelligent building design, the use of quieter equipment on waste collection vehicles and the location of collection points. The main sources of noise associated with domestic waste collections are the emptying of glass from bins into the collection vehicle and reversing alarms.

Councils can assist by replacing high-pitched tonal reversing alarms with alternatives such as broadband alarms, reversing cameras and proximity alarms on their own vehicles and specifying contractor vehicles do the same.

Waste chutes and bin rooms can sometimes be a source of noise from waste falling out the bottom of waste chutes in RFBs, the operation of compacting machines and waste collection vehicles servicing bins from bin storage areas.



### Noise - key questions

- Do the design and location of bin bays and collection points minimise noise impacts?
- Are collection points designed so that collection vehicles do not need to reverse?
- Do pathway and driveway materials minimise noise from bins being wheeled?
- Have double-glazed windows been installed for habitable rooms close to collection points?
- Are waste chutes insulated to avoid noise disturbing habitable areas?

### Odour

Odours can be minimised by having well-ventilated waste storage areas. Air should be allowed to flow through enclosed waste storage and service areas, bin storage and service rooms and waste chute inlets on each floor of a building. Ventilation openings should be protected against flies and vermin and located as near to the ceiling or floor as possible, but away from habitable areas. Forced ventilation or air-conditioning systems for enclosed storage areas should not be connected to the ventilation system that supplies air to habitable areas.

A key resource for ventilation systems is **AS1668.4-2012 *The use of ventilation and air conditioning in buildings***.

Combined food organic and garden organic bins may need to be located out of the sun and washed regularly to minimise odour.

### Odour - key questions

- Are bin storage areas well ventilated?
- Are ventilation openings protected and located away from habitable areas?
- Are ventilation systems separated from ventilation systems that provide air to habitable areas?

### Visual amenity

Poorly designed or located bin storage areas can detract from the overall aesthetics of a building and encourage misuse of the bins.

All waste management facilities, including storage areas, should be screened, so they blend in with the development and are not readily visible from any public place. The bin storage room or area also needs to be clearly labelled to identify it as the waste and recycling room.

Key resource for streetscape and amenity considerations: **Section 4W-1 of the *Apartment Design Guide 2015 (DPE)***



Screened bin storage area fronting a medium-density residential property. (Photo: The Hills Shire Council)

The secure waste and recycling room in the above photo is located directly behind the front street entrance to the property so that bins can be moved to and from the kerb easily. The screening is aesthetically in keeping with the rest of the development.

#### Visual amenity - key questions

- Are bin storage areas screened from public areas so that theft, vandalism and illegal dumping are discouraged?
- Do they blend in with the development, for instance by using similar construction materials?
- Do they blend in with surrounding buildings and landscape?

## 2.9. Ongoing management and maintenance

All waste and recycling storage areas and equipment need to be properly maintained and managed for the life of the building. This is important to help:

- maintain amenity
- maximise safety for residents, caretakers and collectors
- maintain hygiene and prevent spills and litter
- maximise resource recovery
- enable efficient servicing of waste for the development.

Poorly maintained waste, recycling and organics bin rooms and storage areas or equipment will encourage misuse of the waste management services and can impact on amenity, work health and safety (WHS) and the ability for residents to recycle correctly.

### When should ongoing management be considered?

It is important to identify whose responsibility it will be to undertake maintenance and cleaning of waste management facilities in the early planning stages of new developments.

Conditions of consent may require that development complies with the submitted and approved waste management plan. As a result, if a caretaker is specified in the waste management plan, it will be the property owner's responsibility to employ a caretaker before residents start to move in.

## Who will be responsible?

In some cases, this will be the residents, while in others a maintenance and cleaning contractor will be appointed by the Owners' Corporation. The size of the development will also influence who is responsible for ongoing maintenance of the waste management systems and bins. Permanent caretakers or cleaners are recommended for larger developments such as medium-rise and high-rise RFBs and larger mixed-use developments.

## What tasks are involved in ongoing management and maintenance?

It is important to establish and delegate responsibility for the tasks required for ongoing monitoring and maintenance of waste management services and equipment. Addressing incorrect waste behaviours and/or infrastructure issues quickly will help prevent or minimise issues.

The kinds of tasks that may be undertaken by caretakers or cleaners are:

- regular monitoring of waste and resource recovery rooms
- moving bins to and from the collection point, if required, on collection day
- washing bins and maintaining storage areas
- arranging for the prompt removal of dumped rubbish
- maintaining broken or damaged bins, arranging for repairs to waste equipment and removing blockages in chute systems
- displaying and maintaining consistent signs on all bins and in all communal storage areas
- managing communal composting areas, if applicable
- informing residents such as through education materials and demonstrations
- promptly addressing overflowing bins to avoid raids by birds and other animals which can result in waste spilling onto the ground and becoming litter
- maintaining hygiene by promptly addressing infestations of flies, cockroaches and other vermin in bin storage areas.

## 2.10. Work, health and safety

The design of waste systems can have an impact on the work, health and safety of the people who interact with them.

Those at risk include:

- residents using the service
- building management and cleaning staff that maintain the service
- pedestrians and road users
- collection staff providing the service
- waste facility staff
- other people engaged in or affected by the collection service.

**Table 2** provides examples of risks that can be eliminated or controlled through the appropriate design of waste management systems.

**Table 2 Risks and control measures in waste management system design**

Risk	Examples of control measures to be addressed in design
Manual handling injury from moving bins	<p>Ensure adequate space for safe manoeuvring of bins in storage areas and to collection points.</p> <p>Provide enough waste storage space and bin capacity so that bins are not overloaded.</p> <p>Ensure paths for moving bins are free of steps, kerbs and steep grades.</p> <p>Ensure route between waste storage area and collection point is a short distance, flat and unobstructed</p> <p>Locate collection points to enable mechanical servicing of bins.</p>
Vehicle incidents	<p>Ensure collection points are free from obstacles that block driver visibility and are easily accessible for collection vehicles with appropriate overhead clearances, pavement strength and dimensions.</p> <p>Provide adequate manoeuvring and turning space to allow a minimum of 300mm clearance to all structures and services from the maximum loading height and width (including side mirrors) of the collection vehicles accessing a development or building.</p>
Cuts and lacerations or harm from contact with unknown hazardous substances	<p>Keep storage areas clean and all waste, recycling and organics appropriately contained.</p> <p>Ensure education programs and signs are in place showing the safe and appropriate use of bins and receptacles.</p>

Further hazards, risks and appropriate management strategies should be identified through a site-based risk assessment.

Key resources for WHS considerations are:

- **Work Health and Safety Act 2011 (NSW)** and **Work Health and Safety Regulation 2017 (NSW)**
- *The Code of Practice for Collection of Domestic Waste*<sup>4</sup> (SafeWork NSW), which provides guidance on how to prevent injury and illness from the collection of domestic waste.

<sup>4</sup> [www.safework.nsw.gov.au/\\_\\_data/assets/pdf\\_file/0009/52875/Collection-of-domestic-waste-Code-of-practice.pdf](http://www.safework.nsw.gov.au/__data/assets/pdf_file/0009/52875/Collection-of-domestic-waste-Code-of-practice.pdf)

## 3. Low-rise medium-density housing

Waste and resource recovery matters discussed in this section are to be considered alongside 'Section 2: Essential requirements for all developments and building types'.

### 3.1. Defining low-rise medium-density housing

Low-rise medium-density residential development in this guide is consistent with the definition in DPE's *Low Rise Medium Density Design Guide* (Medium Density Design Guide) and means:

- dual occupancies
- manor houses and 'one above the other' dual occupancies – buildings of between two and four dwellings
- multi dwelling housing (townhouses or villas or terraces)

It is development that contains two or more dwellings and is no more than two storeys in height. For examples of these types of development and sample plans, refer to DPE's Medium Density Design Guide<sup>5</sup>.

Since 6 July 2018 these types of development can be carried out under complying development approval, Part 3B of the *State Environmental Planning Policy (Exempt and Complying Development Codes) 2008*.



Typical modern terrace housing (Photo: Elton Consulting)

### 3.2. Key considerations

The main waste management issue for this development type is kerbside presentation of allocated bins. This is because of limited side setbacks to cart the bins to the street and limited frontages from smaller lot sizes. It is considered better practice for attached housing to have individual bin storage areas, so residents can easily wheel their bin to the kerbside for collection.

---

<sup>5</sup> [www.planning.nsw.gov.au/Policy-and-Legislation/Housing/Medium-Density-Housing/Design-Guides-for-Low-Rise-Medium-Density](http://www.planning.nsw.gov.au/Policy-and-Legislation/Housing/Medium-Density-Housing/Design-Guides-for-Low-Rise-Medium-Density)

### Design considerations for attached housing developments

- How many bins per dwelling will be allocated for the development?
- Is the collection point at the front or rear of the property?
- What site factors limit the amount of kerbside space suitable for bin collection?
- What is the bin-carting route for each dwelling?
- Can individual bin storage areas be provided for each dwelling or is a communal bin storage area required?
- Can all allocated bins be presented at kerbside for collection? If not, can council offer an onsite collection?
- Is a wheel-in and wheel-out service available?

## 3.3. Waste management options

Table 3 below illustrates the options that are considered better practice for different types of developments.

Table 3 Better practice waste management options for low-rise medium-density developments

	Dual occupancies	Manor houses and one above the other dual occupancies	Multi-dwelling houses (terraces)	Larger townhouses/villas
Individual bin storage areas with residents carting their bins to the kerbside collection point	✓	✓	✓	
Communal bin storage area with residents/caretaker carting bins to the kerbside collection point		✓		✓
Communal storage area with council providing a wheel-in and wheel-out service (where available)				✓
Communal bin areas with council providing an onsite collection service (where available).				✓

## 3.4. Bin storage areas

### Individual bin storage areas

Individual bin storage areas often facilitate greater ownership of the bins by residents, leading to greater bin maintenance and less contamination of the recycling and organics bin.

This option works best where individual bin storage areas have been considered early in the design process and are convenient for residents to use.

While ground-floor units are likely to have a rear yard that can accommodate individual bin storage areas, greater consideration of appropriate storage areas for first-floor dwellings is needed. It is essential that individual bin storage areas for first-floor units are conveniently located on the ground floor while also protecting the amenity and privacy of ground-floor dwellings. This approach may require the placing of a positive covenant on the property title as a condition of consent to ensure first-floor dwellings have access to an area to store all allocated bins.

Bin storage areas should be located behind the building line of the dwelling, or where it is screened or cannot be viewed from public areas. They should also be located away from windows of habitable rooms and doors of adjoining dwellings to reduce noise and odour. It is not recommended to store bins in garages unless the garage is designed to accommodate a larger size car as well as the footprint of up to 3 x 240L bins with room to manoeuvre.

For further information on the design and location of bin storage areas, see **Section 2.7** and **Section 2.8** for amenity considerations.

Given the limited side access for each dwelling, it is recommended that a clearly identified bin storage area and bin-carting route is provided for each dwelling at the DA stage and illustrated on plans accompanying the DA.

Figures 5, 6 and 7 illustrate examples of how bin storage areas can be integrated into different low-rise medium-density housing.

Figure 5 illustrates attached dwellings with individual bin storage areas per dwelling, the kerbside collection point and bin-carting route.

**Figure 5** Attached housing individual storage

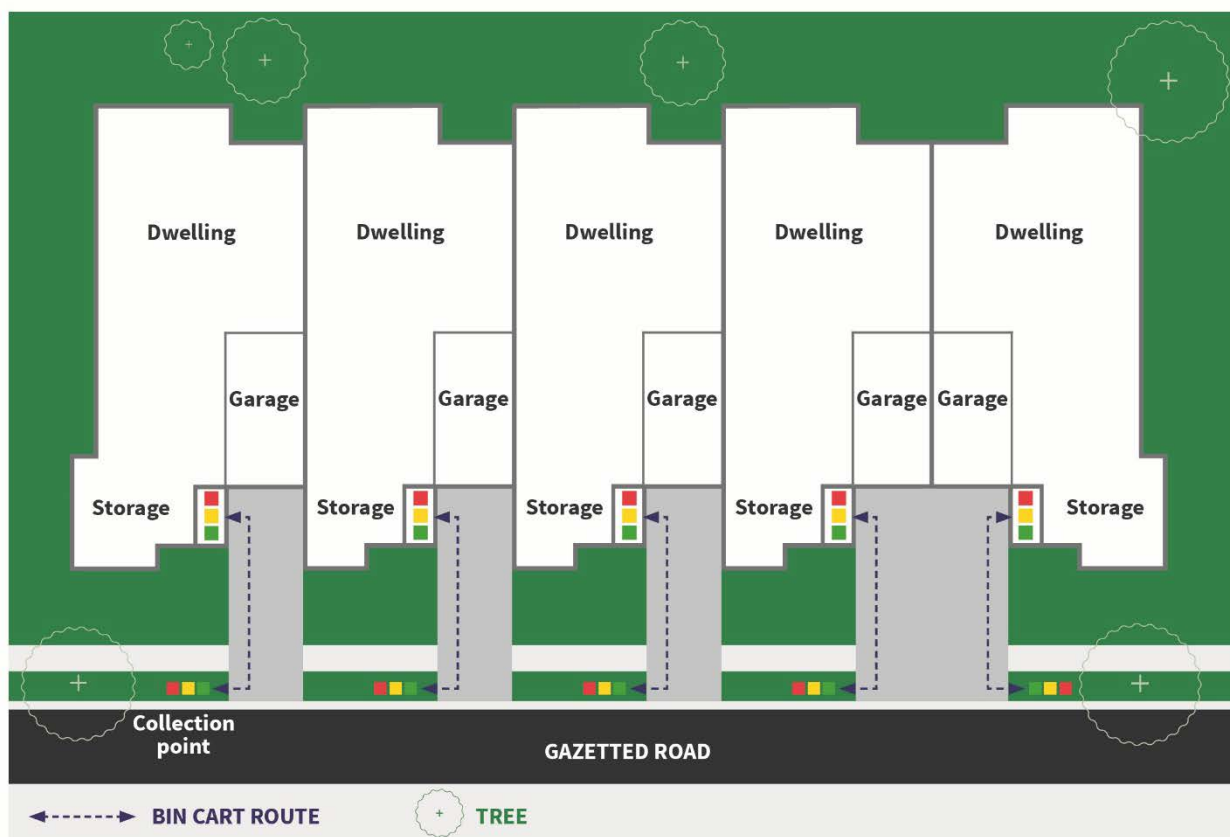

Figure 6 illustrates an example of the development footprint and individual bin storage areas for the four dwellings.

Figure 6 Manor houses individual storage

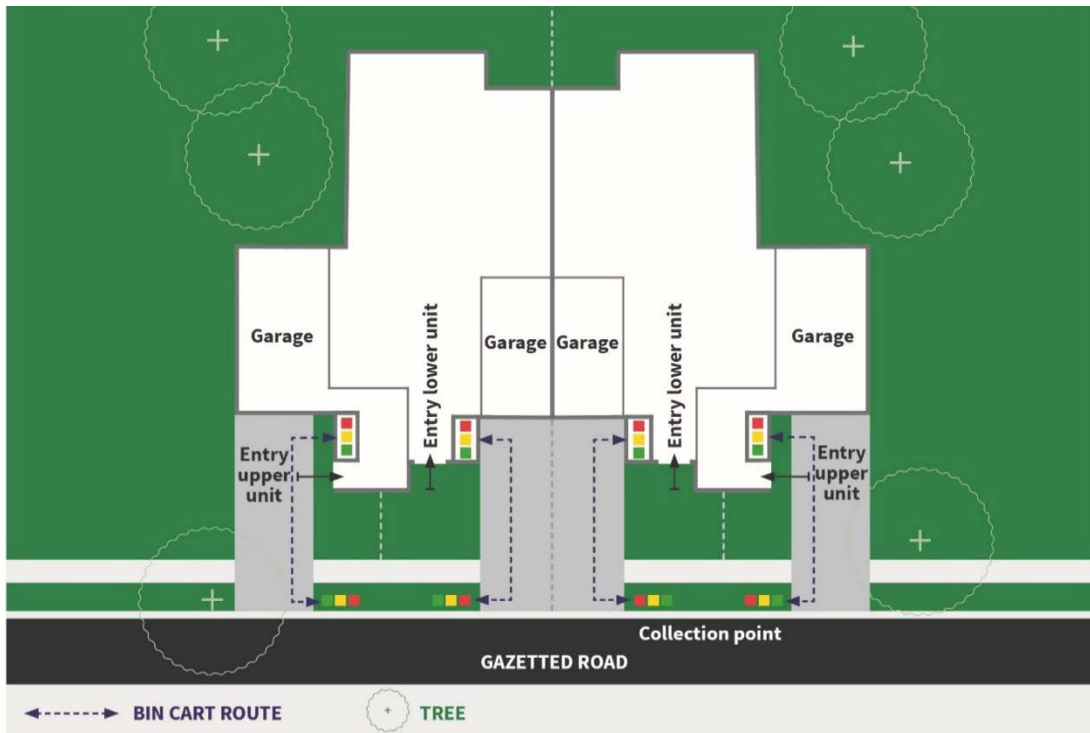
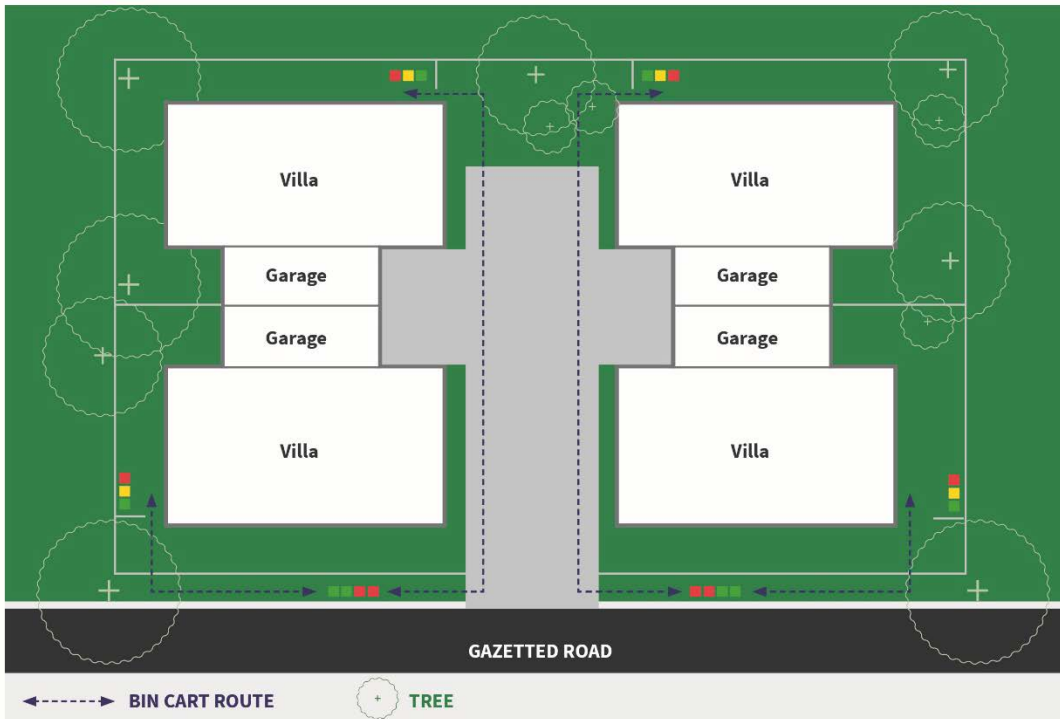

Figure 7 illustrates individual bin storage locations for townhouses and villas with residents taking their own bins to the kerbside collection point and returning them for storage after servicing.

Figure 7 Individual bin storage areas for townhouses and villas





## Communal bin storage areas

Protecting the amenity of all residents and occupants may involve a communal bin storage area that accommodates the bins for all dwellings. For developments built in a complex spread across a large area, more than one street frontage may be involved. Where this is the case, consideration should be given to including more than one communal bin storage area to ensure that residents don't walk more than 30 metres to use their bins.



Communal bin storage for medium-density housing (Photo: Penrith City Council)

Any communal bin storage areas proposed must be:

- easily accessible to all residents (<30 metres from all residential units)
- located to ensure that the bin-carting route for residents to the kerbside collection point is safe and convenient with no steps or steep gradients to manoeuvre bins over
- located at ground level within 10m of the layback from the collection point to facilitate council wheel-in and wheel-out services where available
- designed as freestanding structures with or without a roof enclosure
- designed with the same materials as the main building to preserve aesthetics
- screened with vegetation to help improve amenity.

Figure 8 shows how communal bin storage area can be integrated into the design of manor homes. The communal bin storage area must be located so that it does not adversely impact amenity and the streetscape.

Figure 8 Example of communal bin storage areas for manor homes



Figure 9 is an example of a communal bin storage area in a townhouse or villa complex that allows onsite collection of bulk bins or mobile bins. Residents take their own waste, recycling and organics to the bins in the communal storage area located at the front of the property near the entrance to give waste collection crews easy access.

Figure 9 Example of a communal storage for a townhouse or villa complex with storage areas for bulk bins or mobile bins and onsite collections

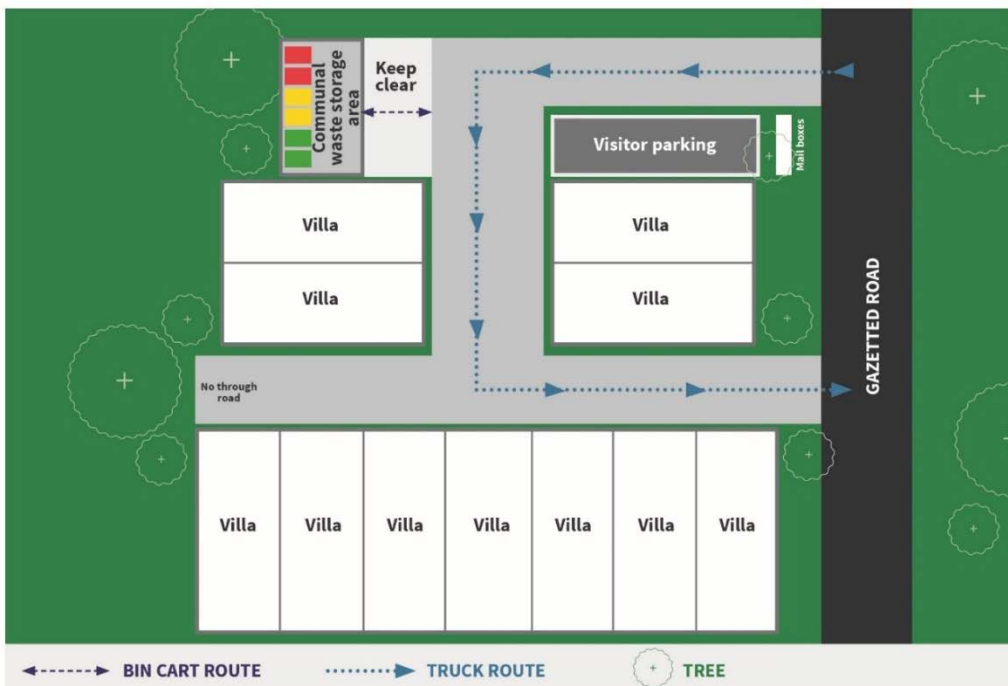

A caretaker may be responsible for taking all bins to the kerbside for collection or bins may be also serviced onsite. The collection vehicle must be able to drive in a forward direction with minimal reversing required to access bins and exit the property in a forward direction.

### 3.5. Collection points

Depending on the waste management option adopted, collection points may be at the kerbside or within the site.

Collection points should be indicated in plans accompanying the DA. For kerbside collection, plans should clearly illustrate that all allocated bins can be accommodated within the street frontage of each individual dwelling to facilitate kerbside collection. For further information on kerbside collection considerations see Appendix B.



Bin collection pads for medium-density housing (Photo: Penrith City Council)

Where there is more than one communal storage area, it may be appropriate to have more than one waste collection point. This would be subject to the width of the street frontage and access issues.

Where onsite collections are proposed, the bin storage area(s) and collection point(s) must take into consideration the layout of the development and be located so that they meet the general requirements specified in Appendix B for onsite collections.

### 3.6. Bin-carting routes

Given that some dwellings will share common walls and have no side setbacks, the bin storage area needs to be located so that the bins can be carted to the kerbside collection point without passing through any internal rooms of the dwelling such as in Figure 4.

The bin-carting route should be illustrated on plans accompanying the DA to demonstrate that bins can be moved safely and efficiently to the kerbside collection point.

### 3.7. Bulky waste storage

It is also considered better practice to provide a space for residents to temporarily store unwanted bulky waste awaiting disposal through the council's clean-up service, such as old furniture, mattresses, appliances and other larger items that will not usually fit in a bin. Council DCPs will often specify this requirement and provide area dimensions and other specifications to be followed.

Areas for bulky waste can be next to or within the main communal bin storage area. This type of storage area is recommended for large townhouse and villa complexes. Where there is no communal bin storage area, residents will need to place bulky waste material at the kerbside for designated collections.

## 4. Residential flat buildings: low-rise

Waste and resource recovery matters discussed in this section are to be considered alongside 'Section 2: Essential requirements for all developments and building types'.

### 4.1. Definition of residential flat buildings: low-rise

A residential flat building (RFB), as defined in the Standard LEP refers to three or more dwellings on one lot of land, but does not include an attached dwelling or multi-dwelling housing. In this guide, the term RFB: low-rise is used to refer to RFBs of two to four storeys.



Riverwood redevelopment, Canterbury (Photo: Elton Consulting)

### 4.2. Key considerations

#### Designing considerations for developments of this scale and density

- How many bins will be allocated for the development and what are their type and sizes?
- Does the local council permit kerbside collection or offer a wheel-in and wheel-out service?
- If onsite collection is required, what are the size and dimensions of the waste collection vehicle that will service the development?
- How many times a week is each bin type collected?

The answers to these questions will vary across council areas and developers and architects are encouraged to consult early with the council to confirm the services it offers.

### 4.3. Waste management options

Better practice waste management for low-rise RFB developments is to provide communal bins. Options include:

- **Option 1:** Mobile bins for waste, recycling and organics stored in a communal bin storage area at ground level and either delivered to the kerbside by a caretaker for collection or by a council wheel-in and wheel-out service (where available)

This option is only viable where the development's street frontage is wide enough to accommodate the number of bins that need to be presented each week. The kerbside collection point must be identified on the DA plans showing enough space for all allocated bins. The kerbside collection point must not affect the functioning of the development's driveway and should be clear of all obstacles and infrastructure, such as overhanging trees, light poles, crossings and bus stops.

In Figure 10 the communal bin storage area is at ground level and located within 10m of the layback from the nominated collection point. This facilitates access to the council's wheel-in and wheel-out service or for kerbside presentation by a caretaker from the bin storage area.

Figure 10 Low-rise RFB Option 1 – Wheel-in and wheel-out service or kerbside collection

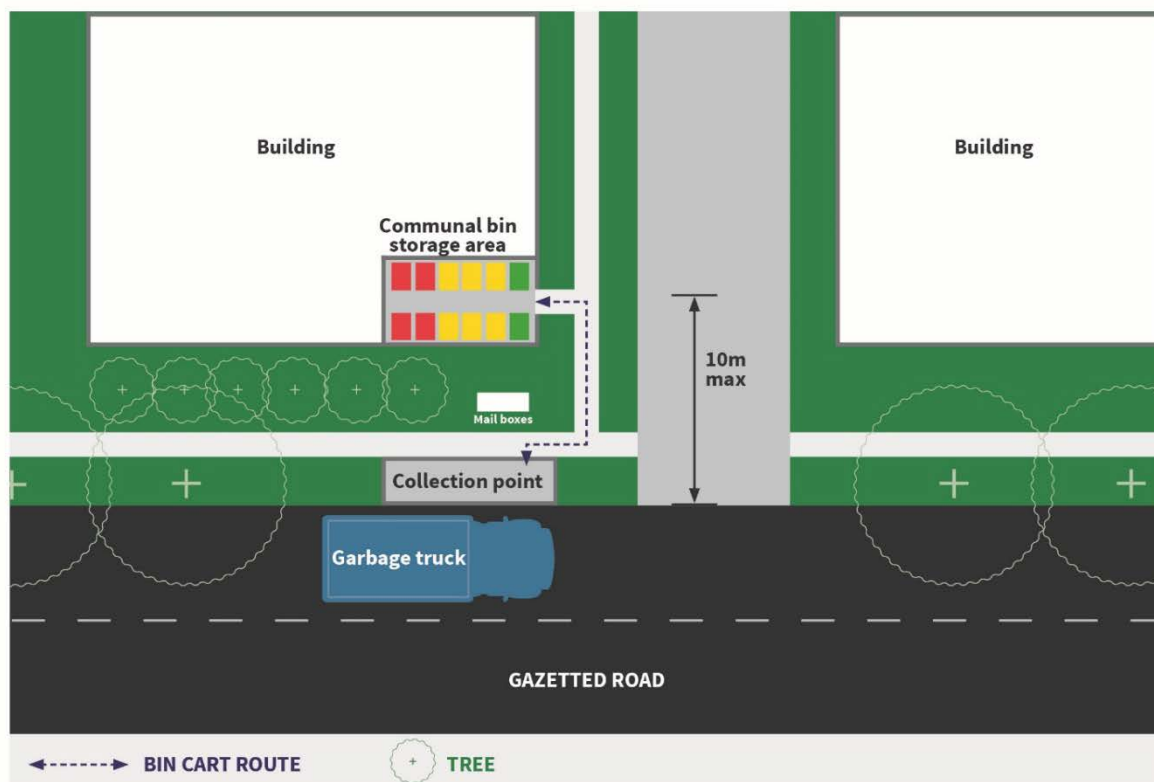

- **Option 2:** Combination of onsite collections and kerbside collections- using a combination of onsite collection of bulk bins and kerbside collection of mobile bins.

Figure 11 Low-rise RFB Option 2 – Combination of onsite and kerbside collections

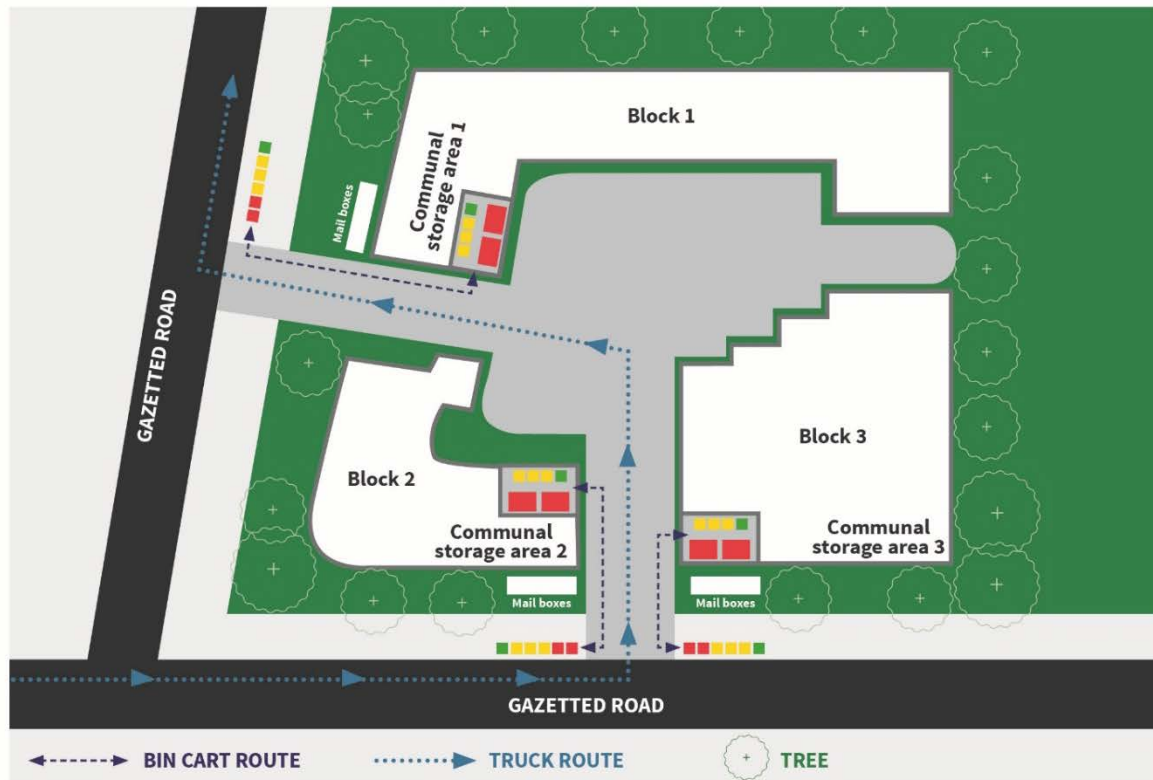

Multiple communal bin storage areas are shown in Figure 11. One communal bin storage area is provided for each block of units. Two street frontages allow for bulk bins and mobile bins to be used to service the development. It is also possible for onsite servicing of bins as the collection vehicles can drive in one entrance and out the other in a forward direction using the dual-access points. In this example, bins may also be serviced from the kerbside on the gazetted road if necessary.

If bins cannot be presented kerbside for collection, early consultation with the council is recommended to establish whether it offers a wheel-in and wheel-out service or whether the development will need to be designed to cater for onsite collection.

Depending on the vehicles used by council, onsite collection and bulk bins may be an option. The use of bulk bins can help reduce the footprint of the bin storage area but may not be the council preferred bin type for all waste and resource recovery streams.

These systems are provided as examples only and are not intended to constrain architects and designers who have other ideas that would achieve better practice waste and recycling outcomes.

Refer to **Appendix G page 100** for advantages and disadvantages of using mobile bins versus bulk bins.

#### 4.4. Bin storage areas

Sometimes the best option for low-rise RFB developments will be to locate the communal bin storage area within the basement of the development. Where bins cannot be serviced from the basement, developers and designers will need to make provision for bins to be readily transferred to the nominated collection point.

Where low-rise RFB developments are spread across a large area with a number of separate apartment blocks, it is better practice to include more than one communal bin storage area within the development. This will help meet the requirement that **residents should only walk a maximum distance of 30m** to use the bins.

Communal bin storage areas should:

- be freestanding structures built with or without a roof enclosure

- be composed of the same materials as the main building to preserve aesthetics
- be screened with vegetation.

## 4.5. Temporary holding areas

Sometimes a temporary bin holding area may be required at ground level. This could be where council offers a wheel-in and wheel-out service and the bins need to be brought up from a basement or the bin storage area cannot be accessed by the waste collection vehicle.

The temporary holding area must be large enough to hold all allocated bins for the development while they await collection. When selecting an appropriate onsite location for the temporary holding area, the health and safety of all users, including caretakers and collection staff, is an important consideration. This includes the path of travel for the transfer of bins (including gradients, surface construction and any obstacles and obstructions), as well as a vehicle loading area.

Developments proposing the use of a temporary holding area will require a caretaker to transfer all allocated bins from the communal bin storage area to the holding area so that the bins can be serviced. Once emptied, bins must be returned to the permanent bin storage area as soon as possible.

## 4.6. Collection points

It is important to identify at an early stage with the local council how the development will be serviced and the most appropriate collection point or points.

Where low-rise developments are spread across a large area and incorporate more than one communal bin storage area, it may be appropriate to have more than one waste collection points, subject to street frontage characteristics and road access.

In most circumstances, where mobile bins are used, the waste collection point is typically on the kerbside. An onsite collection point should be chosen so that it meets the appropriate general requirements specified in **Appendix B**.

Refer to **Appendix H** for information about ensuring waste collection vehicles can appropriately manoeuvre to access and exit the collection point.

## 4.7. Bin pads

At sites where street frontage is limited, it is good practice to include in designs a bin pad to designate bin presentation areas. This option should be considered where councils are concerned with future servicing in laneways. Bin pads can be concreted areas or a stencilled marked area on the ground (as shown in the photos below). This can help to ensure waste collections are considered in the design and a clear, level and safe place is made available at the kerbside for the service to occur.

If this option is to be pursued, it is recommended that the council's engineering and strategic planning teams are contacted to ensure the required road widths are taken into consideration in road networks and layouts in the early design stage.



Bin pads made from concrete (Photo: Camden City Council)

## 4.8. Bulky waste storage

Residents need a space to temporarily store bulky waste awaiting disposal through the council's clean-up service, such as old furniture, mattresses, appliances and other larger items unsuitable for general waste. The types and quantities of materials for collection and volumes allowed per collection may differ between local government areas.

These areas are important safeguards against residents illegally dumping bulky waste on the footpath or within common areas of the building. Regular illegal dumping can attract other dumped waste and generate litter, detracting significantly from the quality and appearance of the development and reduce amenity.

It is important that bulky waste storage areas

- are readily accessible to all residents
- are located at ground level (screened from the street) or in a basement and can be incorporated with the bin storage area
- take into account collection frequency and how councils require materials to be presented prior to pick-up
- be secure and caged to allow the contents to be visible from the outside
- have a minimum doorway width of 1.5 metres to allow for easy movement of large waste items.

Some councils will specify the storage requirements for bulky waste within their DCPs. Where this information is not available, the bulky waste storage should be provided at the rate of 10m<sup>2</sup> of space for up to 40 units and then 2m<sup>2</sup> for every 10 units after that.

Bulky waste should be collected on a regular schedule so that the storage area does not become overfull and residents know when to place items there for collection. Councils may arrange for a more frequent collection of bulky waste from RFBs than is provided from other residences. Alternatively, tenants or building managers may need to make arrangements for extra collections and dispose of bulky waste outside the council-provided collections themselves.





Typical example of issues caused by a lack of appropriate bulk waste storage areas (Photo: Blacktown City Council)



Photo of the same property as above after a screened bin and bulky waste storage area was built. (Photo: Blacktown City Council)

# 5. Residential flat buildings: medium-rise and high-rise

Waste and resource recovery matters discussed in this section are to be considered alongside 'Section 2: Essential requirements for all developments and building types'.

## 5.1. Definition of residential flat buildings: medium-rise and high-rise

A residential flat building (RFB), as defined in the Standard LEP refers to three or more dwellings on one lot of land, but does not include an attached dwelling or multi-dwelling housing. In this guide, the term RFB: medium-rise and high-rise is used to refer to RFBs of four or more storeys. Note that developments of this type require lifts.

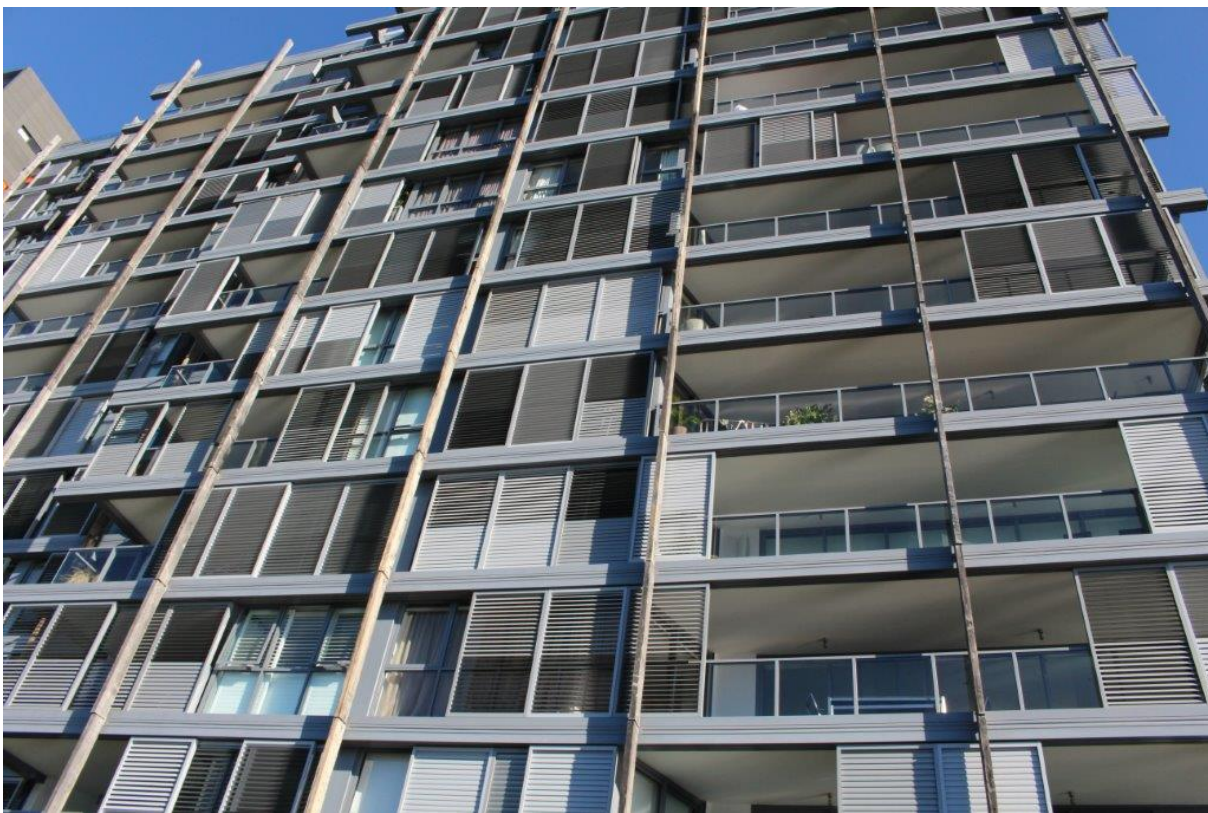

High-rise residential, Bays precinct (Photo: Elton Consulting)

## 5.2. Key considerations

### Design considerations for developments of this scale

- How many bins will be allocated for the development and what are their type and sizes?
- What is the amount of waste, recycling and organics that will be generated from the building?
- What are council's waste collection services, its waste management policies and the type and dimensions of collection vehicles?

Decisions on these issues will be crucial in building design and can have a long-lasting impact on the amenity of the building. Significant care and consideration is especially important for high-rise buildings. Due to the large amount of waste generated, poor design decisions can have serious consequences for the management of a building throughout its lifetime.

To help design the bin storage area, the council’s DCP or waste management department should be consulted to help quantify all the waste and recyclables that will be generated from the building.

Refer to **Appendix F** for approximate waste and recycling generation rates that can be followed if the council is unable to provide this information.

### 5.3. Waste management options

In medium- and high-rise RFB developments, it is better practice to provide onsite collections for all waste, recycling (and organics where this service is available). Kerbside collection is unlikely to be operationally feasible and would likely result in traffic, car parking and safety issues. For medium-rise developments with 20 or fewer dwellings, kerbside collection is an option. In high-rise RFB developments, the most efficient method for collection is chute systems.

Possible waste and resource recovery system options for medium- and high-rise RFB developments are set out in **Table 4**.

**Table 4 Waste management options for medium- and high-rise RFBs**

Description	Comments	Medium-rise	High-rise
<p><b>Option 1</b> Bin storage and service rooms on each floor for waste, recycling (and possibly organics)</p> <p>Refer to <b>Appendix C</b> for further information about bin storage areas</p>	<p>A caretaker is responsible for swapping full bins with empty bins and moving bins from the communal storage area to the collection point. In some cases, waste and/or recycling can be decanted into bulk bins ready for collection. This can help save space.</p> <p>Bins can either be serviced at the kerbside or onsite, except when using bulk bins and where onsite collections are preferred by council. If serviced from the kerbside, it is the responsibility of a caretaker or council waste contactor (where a wheel-in and wheel-out service is offered) to move bins to the kerbside and return them to the bin storage area.</p>	<p>✓ Up to 20 dwellings</p>	
<p><b>Option 2</b> Single-chute system for waste and a service room on each floor for recyclables</p> <p>Refer to <b>Appendix G</b> for further information about chute systems</p>	<p>A single-chute system for waste only is installed. Recycling (and possibly organics) is collected from bins stored in a bin storage and service room located on each floor. This room contains the chute inlet and enough space for one or two mobile bins for residents to deposit recyclables.</p> <p>A caretaker is responsible for swapping full bins with empties and transporting them to the main storage area to await collection. Where space is restricted, recycling can be transferred into bulk bins for collection.</p>	<p>✓</p>	<p>✓</p>
<p><b>Option 3</b> Single-chute system with diverter</p> <p>Refer to <b>Appendix G</b> for further information about chute systems</p>	<p>A single-chute system with a switching device allows it to accept both waste and recycling.</p> <p>The chute system allows users to press a button to select either waste or recycling (or potentially organics) which is diverted into the correct bin at the bottom of the chute. The chute inlet can be located in a bin storage and service room or a small bin cupboard located on each floor.</p>	<p>✓</p>	<p>✓ Up to 10 storeys only</p>
<p><b>Option 4</b> Dual-chute system for waste and recycling</p> <p>Refer to <b>Appendix G</b> for further information about chute systems</p>	<p>Dual chutes are installed for waste and recycling. Chute inlets can be placed inside a bin cupboard or small waste room.</p> <p>The waste is collected in bulk bins, usually in the basement and is often compacted.</p> <p>All waste streams are collected onsite.</p>	<p>✓</p>	<p>✓</p>

Residents only have access to the bulky waste storage area and any additional recycling bins located in the basement.

**Option 5**

Automated waste collection system (AWCS) for waste and recycling

An AWCS consists of networks of underground pipes that transport waste to a receiving station, which can be located onsite or offsite. AWCS can accept up to three separate waste streams (waste, recycling and organics). The chute inlets to the system are located on each floor of the building.

✓

Refer to **Appendix D** for further information about AWCS

These systems are better suited to high density RFBs of up to 1,000 units or in staged developments where a number of buildings will be located close to each other, allowing systems to be linked and taking advantage of economies of scale.

These systems are provided as examples only and are not intended to constrain architects and designers who have other ideas that would achieve better practice waste and resource recovery outcomes.



Four 660L bins underneath a waste chute with a ceiling-mounted compactor with bins rotated manually by the cleaner (Photo: Andrew Quinn)

**Deciding which system to use**

This decision will depend on the size and layout of the building and budget constraints. The key advantages, disadvantages and system requirements of the options are outlined in **Table 5**.

**Table 5** Advantages and disadvantages of waste management options for medium-rise and high-rise RFBs

	Advantages	Disadvantages	System requirements
<p><b>Option 1</b> Bin storage and service rooms on each floor for waste and</p>	<ul style="list-style-type: none"> <li>Simple to use</li> <li>Encourages resource recovery through co-locating waste, recycling and possibly organics</li> </ul>	<ul style="list-style-type: none"> <li>Requires regular transfer of all bins to and from main bin storage area by cleaning staff</li> <li>Requires regular monitoring of bin or</li> </ul>	<ul style="list-style-type: none"> <li>BCA compliance for bin storage and service rooms</li> <li>A hydraulic or gas strut bin lifter may be required</li> </ul>

resource recovery	<ul style="list-style-type: none"> <li>• Caretakers can monitor contamination in bins</li> <li>• Reduced breakage of glass</li> </ul>	<ul style="list-style-type: none"> <li>• crates fullness on each floor of the building</li> <li>• Increased likelihood of manual handling injuries due to movement of bins. Residents may dump bulky waste in bin storage rooms</li> <li>• High level of ongoing management for bin transfer and maintenance of bin storage and service room</li> </ul>	<ul style="list-style-type: none"> <li>• for decanting waste into bulk bins</li> <li>• Enough space in bin storage and service room for bins</li> <li>• Safe bin-carting routes</li> <li>• Supply of spare bins to be kept in main bin storage area</li> </ul>
<b>Option 2</b> Single-chute system for waste and service rooms on each floor for waste and resource recovery	<ul style="list-style-type: none"> <li>• Simple to use</li> <li>• Encourages resource recovery through co-locating waste, recycling and possibly organics</li> <li>• Caretakers can monitor contamination in all bins</li> <li>• No need for residents to carry waste up and down stairs or lifts</li> <li>• Compactor bins under waste chute outlet save space</li> <li>• Reduced breakage of glass</li> </ul>	<ul style="list-style-type: none"> <li>• Requires regular transfer of recycling and possibly organics bins to and from main bin storage area</li> <li>• Requires regular monitoring of bin or crates' fullness on each floor of the building</li> <li>• Residents may dump bulky waste in chutes</li> <li>• Contamination risk if residents place items that cannot fit down chutes into recycling bins</li> <li>• Costs and space requirements for bin storage on each floor, compared with only chute</li> </ul>	<ul style="list-style-type: none"> <li>• Refer to Option 1, and:</li> <li>• Caretaker to maintain chutes and rotate bins under chute outlets</li> <li>• Restrict resident access to bin storage and service rooms on each floor and the bulky waste storage area</li> </ul>
<b>Option 3</b> Single-chute system with diverter	<ul style="list-style-type: none"> <li>• Simple to use</li> <li>• Minimises bin movement through the building</li> <li>• No need for residents to carry waste and recyclables up and down stairs or lifts</li> <li>• No need for manual transfer of bins</li> <li>• Cost and space savings by not building bin storage room on each floor or separate chutes</li> <li>• Compactor bins under waste chute outlet save space</li> </ul>	<ul style="list-style-type: none"> <li>• Same as Option 4, and:</li> <li>• Reliant on residents selecting the correct button</li> <li>• Residents may be less committed to sorting recyclables if they perceive the material ends up in the same location</li> <li>• The delay required for chute to divert to the selected stream can be longer in high-rise buildings where people on different floors require use of the chute at the same time</li> </ul>	<ul style="list-style-type: none"> <li>• Caretaker to maintain chutes and rotate bins under chute outlets</li> <li>• Restrict resident access to bulky waste storage in basement</li> <li>• Clear signage to explain what each chute is for</li> <li>• Further information should be obtained from the equipment supplier</li> <li>• Not suitable for high-rise buildings with more than 10 storeys</li> </ul>
<b>Option 4</b> Dual-chute system for waste and recycling	<ul style="list-style-type: none"> <li>• Same as Option 3</li> </ul>	<ul style="list-style-type: none"> <li>• Increased capital cost for installation of two chutes</li> <li>• Residents may dump bulky waste in chutes leading to blockages</li> <li>• Contamination risk if residents place wrong items in recycling chute</li> </ul>	<ul style="list-style-type: none"> <li>• Refer to Option 3</li> </ul>

- Difficult to identify who is misusing the chute system
- Difficult to recycle organics

**Option 5**

Automated waste collection system (AWCS) for waste and recycling

- Simple to use
- Can be designed to accept food organics
- Fewer waste collections reduces noise, traffic congestion and air pollution
- Improves WHS by reducing manual handling
- Seamless waste management that can integrate street bins
- Ideal for pedestrian-oriented developments where heavy vehicle access is difficult
- Expensive to install
- Requires underground pipe network
- Glass can only be collected in limited quantities
- Recycling needs to be bagged before being deposited into the inlet, which is not in line with current waste education for recycling
- Bulky items can jam chute inlet
- Cost-benefit analysis recommended
- On-call caretaker for maintenance, care and cleaning required
- If integrated into the basement of a building, a basement clearance height of 4.5m is required
- Not yet trialled in Australia
- Ongoing and clear education to residents and caretakers on how to use the system correctly will be necessary

The Western Sydney Regional Organisation of Councils (WSROC), through the assistance of the EPA, has produced fact sheets that provide additional information on high-rise residential waste infrastructure. These can be downloaded from their website: [www.wsroc.com.au/media-a-resources/reports](http://www.wsroc.com.au/media-a-resources/reports)

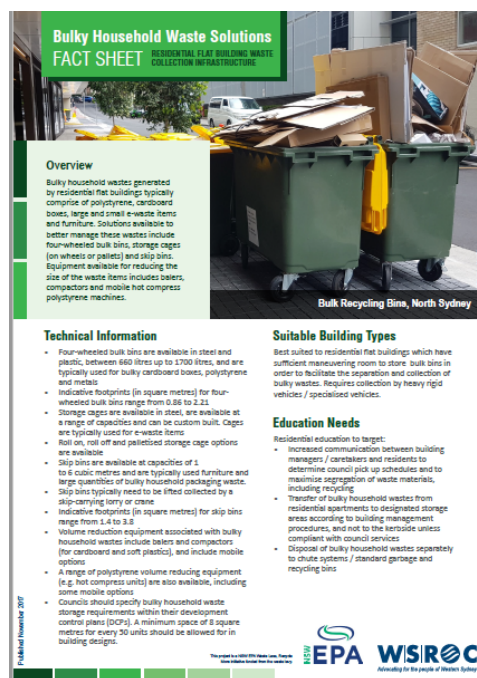
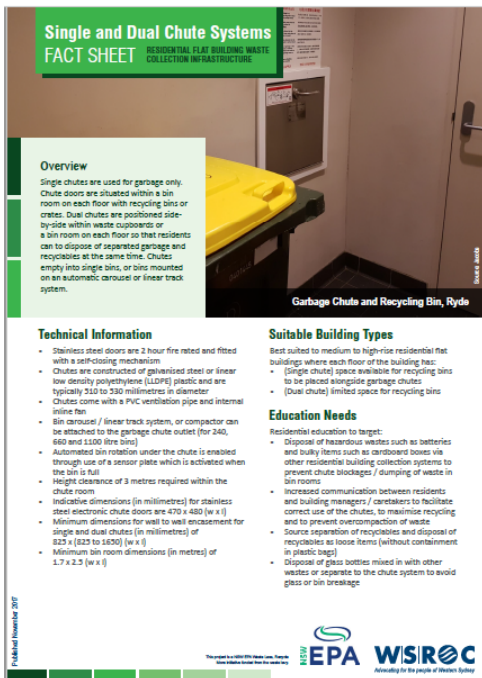

**Bin storage areas**

For medium- and high-rise RFBs, a communal bin storage area is necessary.

A bin storage and service room is usually located on each habitable floor containing the chute inlet(s) and, in some options, enough room for one or two mobile bins or crates for residents to deposit recycling.

A bin storage area in the basement stores extra bins used to rotate full bins in the bin storage and service rooms. This room may or may not have restricted access for residents.

Refer to **Appendix C** for information on location and design of bin storage areas.

## 5.4. Temporary holding areas

Councils may offer a wheel-in and wheel-out service for medium-rise RFBs. Where this waste management option is chosen for a development, a temporary holding area will be required at ground level.

The temporary holding area must be large enough to hold all allocated bins for the development while they await collection. When selecting an appropriate onsite location for the temporary holding area, the health and safety of all users, including caretakers and collection staff, is an important consideration. This includes the path of travel for the transfer of bins (including gradients, surface construction and any obstacles and obstructions), as well as a vehicle loading area.

Developments proposing the use of a temporary holding area will require a caretaker to transfer all allocated bins from the communal bin storage area to the holding area so that the bins can be serviced. Once emptied, bins must be returned to the permanent bin storage area as soon as possible.

## 5.5. Collection points

These developments should be serviced through onsite collection. This means the council's collection vehicle will enter the property and service the development within the property boundary from a designated loading area.

The development must provide safe vehicle access and enable the waste collection vehicle to manoeuvre and load all allocated bins.

Refer to **Appendix B** for further information on design considerations for onsite collection.



Onsite collection of 660L recycling bins– RFB Kingswood (Photo: Penrith City Council)

## 5.6. Bulky waste storage

A dedicated room or caged area is needed for residents to temporarily store discarded bulky waste prior to collection by council's clean-up service. Bulky waste includes old furniture, mattresses, appliances and other larger items that will not usually fit in a bin.

These areas are important safeguards against residents illegally dumping bulky waste in common areas or the footpath. Regular illegal dumping can attract other dumped waste and generate litter, detracting significantly from the quality and appearance of the development and reduce amenity of the street. This is a particular problem around RFBs due to the high numbers of residents moving in and out.

In these development types, the bulky waste storage area should:

- be readily accessible to all residents
- be located at ground level (screened from the street) or in a basement and can be incorporated with the bin storage area.
- take into account the collection frequency and how the contents will be removed i.e. will council collect the materials directly from the room or will they need to be brought kerbside for collection, do councils require separation of types of bulky waste?
- be secure and caged to allow the contents to be visible from the outside
- have a minimum doorway width of 1.5 metres to allow for easy movement of large waste items.

Some councils will specify the storage requirements for bulky waste within their DCPs. Where this information is not available, the bulky waste storage should be provided at the rate of 10m<sup>2</sup> of space for up to 40 units and then 2m<sup>2</sup> for every 10 units after that.

Bulky waste should be collected on a regular schedule so that the storage area does not become overfull and residents know when to place items there for collection. Councils may arrange for a more frequent collection of bulky waste for RFBs. Alternatively, residents or building managers may need to make extra arrangements to collect and dispose of bulky waste themselves.

The types and quantities of materials allowed for collections and volumes allowed per collection may differ between local government areas.

## 5.7. Problem waste and other resource recovery

For large RFBs the volume of problem waste and other recyclable materials makes alternative collection services for residents a viable option. Where services are available, collection arrangements with council or third parties and charities can be made for the following materials:

- unwanted clothing and shoes
- printer cartridges
- household batteries
- fluorescent bulbs or tubes, light bulbs
- e-waste including mobile phones and accessories
- polystyrene
- excess bulky cardboard.



Problem waste storage area for e-waste, polystyrene, clothing and recyclables in the basement of a high-rise building – (Photo: City of Canterbury Bankstown)

Containers used to store these materials can be located in basement car parks, in separate bin storage areas or at nominated points in the building that are likely to be frequented by residents (such as



household battery and mobile phone bins in the building foyer or near lift cores) and organised by the Owners' Corporation.

It is recommended that as a minimum in all medium- and high-rise developments, space is made available for:

- at least one charity clothing bin for use by the residents only
- a bulk bin (660 or 1100L) for separating and storing excess bulky cardboard

The EPA has developed icons for its Community Recycling Centre Program that can be used as posters in bin rooms. Contact the EPA for access to the artwork and to discuss the collection of problem waste.

Refer to **Case Study 1** (page 52) for an example of a building that has successfully introduced problem waste collections.

The NSW container deposit scheme, *Return and Earn*, began rolling out across NSW on 1 December 2017. Most NSW beverage containers between 150 millilitres and 3 litres in volume are eligible for a 10-cent refund. They contain materials including:

- PET
- HDPE
- glass
- aluminium
- steel
- liquid paperboard.

Containers should be empty, uncrushed, unbroken and have the original label attached. Once collected these materials can be taken to a collection point to redeem the 10-cent refund.

Residential flat buildings provide an opportunity for eligible containers to be collected in a separate bin or storage containers. The beverage containers can then be taken to a collection point to redeem the 10-cent refund. Money redeemed can be shared among the residents or used for improvements in the building.

The collection of beverage containers for the *Return and Earn* scheme can only work if there is a building champion prepared to establish a collection bin, monitor it for ineligible containers and transport the containers to their nearest collection point. The system also requires space in the bin storage area or recycling area for extra bins or containers to collect the beverage containers.

Architects and building designers looking to establish better practice resource recovery outcomes for residential flat buildings should consider providing space for the recovery of a range of materials other than the traditional streams of waste, recycling, bulky cardboard and organics. Providing space for different waste streams such as e-waste, household batteries, polystyrene, clothing and *Return and Earn* containers will help to:

- Increase resource recovery rates for the building
- Provide residents with a convenient and correct way to dispose of problem waste
- Reduce the total number of bins required for waste and recycling
- Help count towards green and environmental building awards and point systems

Architects and designers should consult with council waste management sections to identify if council or other third parties operate in the area that could service different waste and material streams.

## 5.8. Supporting infrastructure

Where mobile bins containing waste, recycling or organics are required to be emptied into bulk bins, suitable bin lifter equipment must be provided to eliminate the risks associated with manually lifting and emptying bins.

Where the bins need to be transported an excessive distance or there is a large number of bins to transport around the site, speciality bin moving equipment should be used.

Refer to **Appendix G** for further information on bin lifter and bin moving equipment.

## 5.9. Access

Access for residents to waste facilities should be limited to the bin storage and service room located on each floor (where included) and the bulky waste storage area. Residents should be restricted from accessing rooms containing compacting equipment or chutes to help prevent damage or injury from misuse of this equipment. If vandalism or illegal dumping of waste is likely, waste rooms and storage areas should be locked and secured.

## 5.10. Ongoing management

All waste management systems in medium-rise and high-rise developments require some degree of ongoing management. It may be necessary to employ a caretaker or building manager to:

- clean bins and keep waste storage areas tidy
- manage the transfer of waste and/or recycling and organics bins from the bin storage and service rooms to the bin storage area and/or to the collection point
- regularly monitor all bins and educate residents on how to use the waste and resource recovery services
- maintain and check all waste management equipment, such as chutes, bin lifts, compactors and other equipment
- liaise with the council or the collection contractor on waste management issues
- arrange collection of containers and bins when full where the service is not provided by council such as e-waste or other problem waste collections.



Building Managers RFB (Photo: City of Canterbury Bankstown)

Conditions of consent may require a development to comply with the submitted and approved waste management plan, including requiring the employment of a caretaker. Active caretakers are vital for effective ongoing management in large developments.

## Case Study 1: Medium-rise residential flat building

### The property

Address: Rosebery

Development: Medium-rise residential flat building

Municipality: City of Sydney

This new residential flat building development consists of two connected buildings of four residential storeys each and a total of 88 units.

### Waste services

Each building has its own core through which dual waste and recycling chutes run to the basement. Resident access to the chute inlets is by two small side-by-side doors in a cabinet located in the corridor next to the fire reel storage. The chutes empty directly into 660L bins in the basement, one for waste and one for recyclables. The bins under the chutes are changed every day by cleaners.

The bin rooms where the chute discharges into are large enough to store spare bins as well as the cleaners' supplies and equipment and bulky waste. Residents have access to the chute rooms in the basement for disposal of bulky household waste.

Building management reports that the recycling chutes work well, and that material collected in the bins is relatively free of contamination.



660L bulk waste bin under chute in the bin storage room (Photo: Andrew Quinn)



Bin cabinet containing the dual waste and recycling chute hoppers (Photo: Andrew Quinn)

### **Waste collection**

Bins are taken by cleaners from the chute rooms to the main loading dock. The waste collection service is provided by the City of Sydney. The loading dock features a vehicle turntable that allows collection vehicles to enter the site forward, turn in the dock, reverse a short distance to the bins and then drive out in a forward direction.

### **Security and safety**

The development is entirely secure and includes a roller door between the loading dock vestibule and the street, and another roller door between the vestibule and the dock where the bins are located. The turntable also cannot be operated without a key.

### **Educational material and signage**

Each new resident is provided with a USB memory stick that contains all the information they need about the building. This includes waste management and resource recovery information.

City of Sydney Council posters and labels are provided at the chute inlets and in the chute rooms in the basement. This information describes what materials can be recycled. Information is also provided on how to book clean-up services for bulky waste.

## 6. Mixed-use developments

Waste and resource recovery matters discussed in this section are to be considered alongside 'Section 2: Essential requirements for all developments and building types'.

### 6.1. Definition of a mixed-use development

Mixed-use development is defined as development which comprises a mixture of two or more land uses, either within a single building (horizontally or vertically) or multiple buildings of different uses within a distinct development site (precinct).

Mixed-use developments can be small or large. Examples include:

- two storey building incorporating a residential property on the top floor and commercial outlet on ground level, commonly referred to as 'shop top housing'
- one or more levels of commercial outlets beneath low-, medium- or high-rise RFBs.

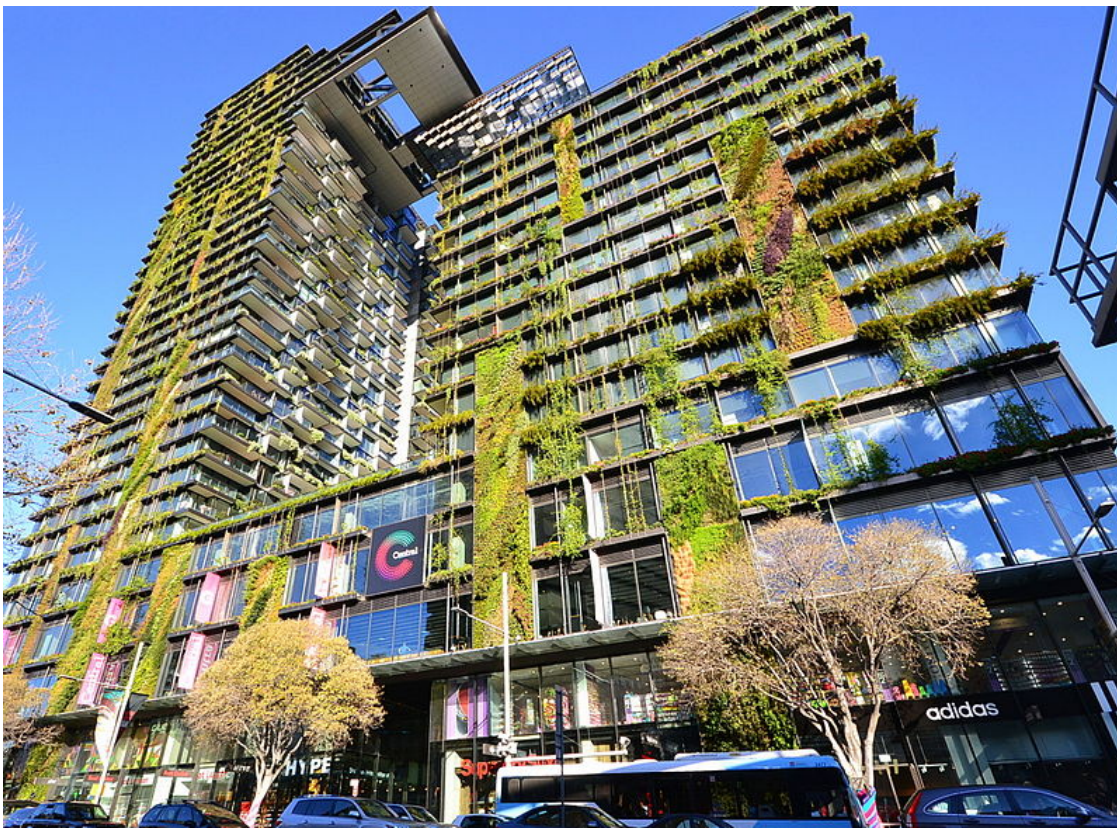

One Central Park, Broadway, Sydney (Photo Elton Consulting)

### 6.2. Key considerations

In mixed-use developments, **waste management areas for residential premises and commercial outlets must be kept separate**. Residential and commercial tenants should be prevented from using each other's waste facilities.

Waste collection and disposal is a business expense which is contracted and paid for by the business. Residents are generally levied fees from the Body Corporate and/or council to manage their general wastes. Common issues that can arise if commercial tenants and residents share waste facilities are overloaded bins, waste contamination, unhygienic conditions and disputes over payment for waste services.

The simplest way to keep commercial and residential waste management systems separate is to build two separate and lockable bin storage areas that are only accessible by keys or swipe cards.

Waste management systems for commercial tenants must also be designed and managed so that they minimise the noise and odour impact on residential dwellings within the development.

**The waste management plan for the development must identify:**

- the separate bin storage and resource recovery areas for the commercial and residential components
- the bin-carting routes
- the collection point for the commercial and residential bins
- storage rooms for any waste management equipment that will be used by the commercial premises and those that will only be used by the residential component
- waste chutes where proposed.

### 6.3. Provision of services

Local councils are not required to provide commercial waste services to businesses and in most cases will only service the residential component. Business owners are therefore required to contract a waste service provider to collect their business waste and recyclables.

### 6.4. Waste types and handling methods

Waste materials from residential and commercial properties differ in quantity and composition. When determining waste handling and storage requirements for mixed-use developments, consideration must be given to:

- the mix and type of retail and commercial outlets that may occupy the development and the types and quantities of waste, recycling and organics they may generate (refer to **Appendix F**)
- the number of residential dwellings and the quantity of residential waste and recycling they will generate (refer to **Appendix F**)
- the waste infrastructure (bins and any other waste management equipment) that may be required to separately manage the commercial units' waste – for example, retailers may install cardboard balers to manage large amounts of cardboard and restaurants may generate food waste that may require more frequent collection.
- the waste infrastructure needed to manage the residential component, such as chutes, compactors and bulk bins or wheelie bins (refer to **Appendix G**)
- the need for service lifts to transfer waste from different levels of the building to the waste storage area(s).

The waste management systems for the commercial and residential components must be easy to use while not impacting on each other.

## 6.5. Waste management options

### Residential

Refer to the relevant residential development type for better practice waste management for the residential component of mixed-use developments.

Figure 12 shows the possible basement layout of a secure waste storage area for residents of a mixed-use development. Residents' access to waste and resource recovery facilities is limited to the bin storage and service room on each residential floor and a bulky waste storage area. Access to the basement chute rooms is restricted to the caretaker for safety reasons and to discourage people from dumping waste.

Figure 12 Chute system for the residential waste component of a medium-density mixed-use development

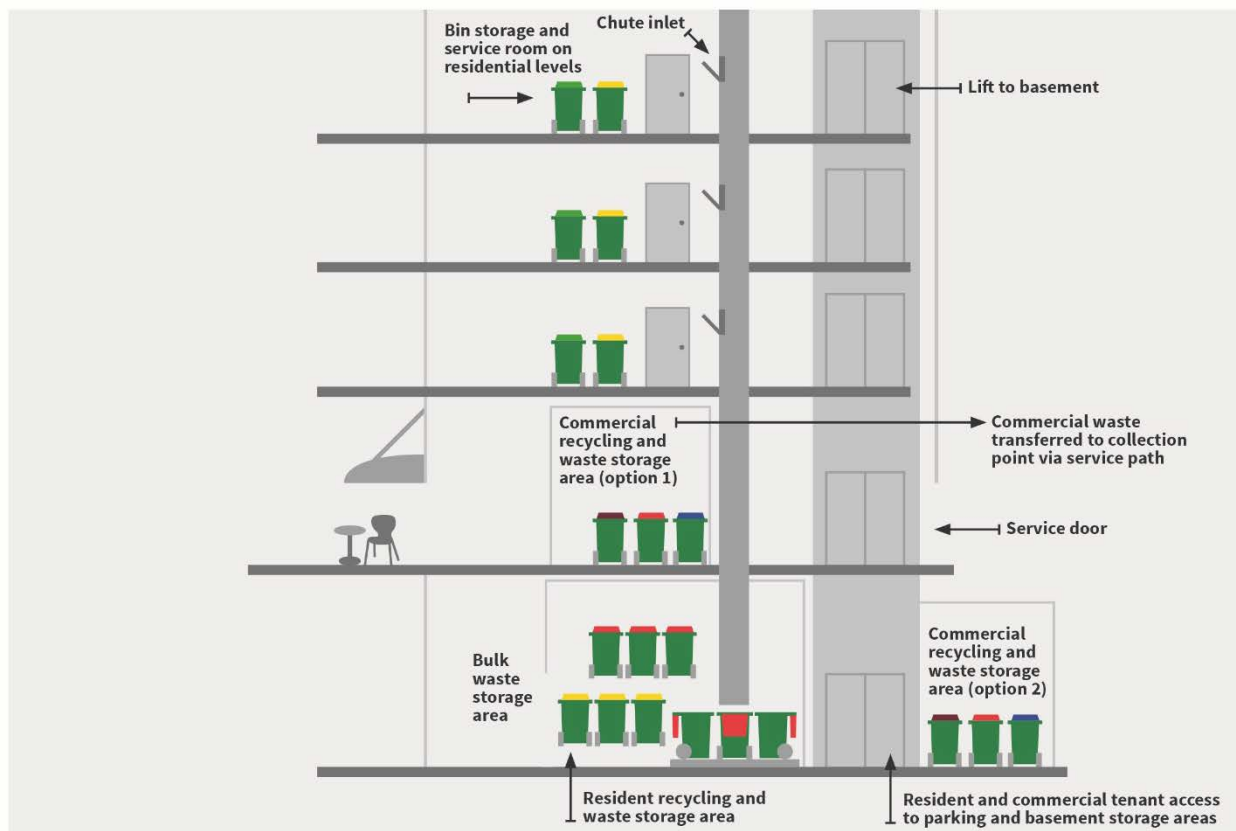

Waste storage and resource recovery areas for commercial developments are provided either at ground level or in a separate storage area in the basement.

### Commercial

Waste and resource recovery systems installed in commercial developments will vary according to the mix of businesses and the types and quantities of waste and recyclables generated.

This guide does not cover specific waste management requirements for commercial developments, other than how the commercial waste management system should integrate with residential services in mixed-use developments. The EPA's companion document, *Better practice guidelines for waste management and recycling in commercial facilities* (2012)<sup>6</sup>, deals with commercial waste.

<sup>6</sup> [www.epa.nsw.gov.au/-/media/epa/corporate-site/resources/managewaste/120960-comm-ind.pdf](http://www.epa.nsw.gov.au/-/media/epa/corporate-site/resources/managewaste/120960-comm-ind.pdf)

## 6.6. Bin storage areas

Enough space must be provided to store all waste, recycling and organics likely to be generated by commercial tenants and residents between collection days as well as the equipment to manage it. There are a number of arrangements that could be suitable and comply with better practice principles. It is always advisable to consult with council engineers, planners and waste managers regarding development requirements specific to a local area.

Figure 13 shows separate waste storage areas for residential and commercial waste in a mixed-use development. Mobile 240L bins and bulk bins are used for waste, recycling and organics, with bins kept in a communal storage area.

Figure 13 Low-rise mixed-use separate waste and recycling storage areas

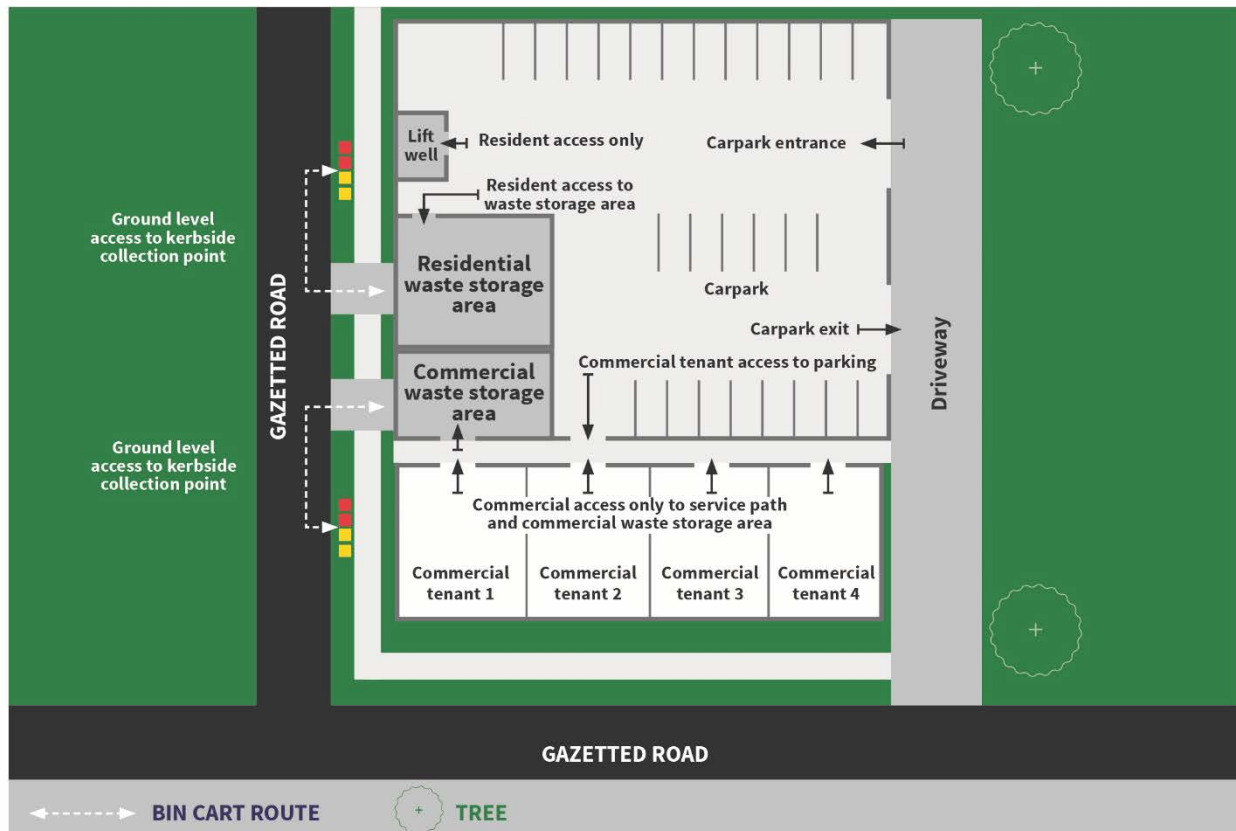

Access to the residential communal bin storage area is by way of a passage next to the residential lift well. Access to the bin storage area is limited to residents and caretakers only. Access to the commercial bin storage area is by a service area at the rear of the commercial units with restricted access from the residential area.

This figure could also represent a building with bin storage and service rooms on each floor for recycling and organics where a caretaker takes waste, recycling and organics bins from each floor to the communal storage area via the lift. Caretakers also have access to the bin storerooms directly from the parking area. This would normally be kept locked and opened only as required to allow for regular cleaning and maintenance.

There is ground-level access from both the residential and commercial waste storage areas to allow bins to be wheeled to and from the kerbside for collection. A caretaker would be required to do this.



## Residential waste and resource recovery bin storage areas

**Refer to the relevant residential development type for better practice bin storage area design and location for the residential component of mixed-use developments. This includes provision of bulky waste and problem waste options.**

Each commercial unit should have a clearly defined internal storage space sized to allow safe and hygienic separation of waste and recyclables prior to transport to the bin storage area.

### Commercial bin storage areas

The commercial uses within the building may be unknown at the DA stage. Waste, recycling and organics generation can vary significantly with business type as can requirements for frequency of bin collections. Designers should therefore be conservative when estimating the amount of space to allocate to the commercial bin storage area and provide flexibility to support either expanding or reducing this space, once needs are better understood.

Other considerations when designing the commercial bin storage areas include the need to keep collections from disturbing residents, impacts on loading dock activities of the business, car parks and aesthetics and odour impacts on residents or customers.

Adequate space to store waste, recycling and organics bins for the commercial premises must be indicated on the architectural drawings.

## 6.7. Supporting infrastructure

Where mobile bins containing waste, recycling or organics have to be emptied into bulk bins, suitable bin lifter equipment must be provided to eliminate the risks associated with manually lifting and emptying. Bin lifting equipment may be needed for both the residential and commercial components of the development. Sharing this equipment may be possible in developments where the same caretaker is responsible for both areas.

Where the bins need to be transported an excessive distance or there is a large number of bins to transport around the site, specialised bin moving equipment should be used.

Refer to **Appendix G** for further information on bin lifter and bin moving equipment.

## 6.8. Ongoing management

Depending on the size of the overall development, a caretaker or building manager may be required. Caretakers are recommended for medium and high-rise developments and they will also be required to maintain the commercial waste management systems. Their main responsibilities include:

- cleaning bins and keeping waste storage areas tidy
- managing the transfer of waste, recycling and/or organics bins from the bin storage and service rooms to the bin storage area and/or to the collection point
- regularly monitoring bins and educating residents on how to use the waste and recycling services
- maintaining and checking all waste management equipment, such as chutes, bin lifts, compactors and other equipment
- ensuring security provisions are maintained, including monitoring whether there is any cross-contamination by commercial tenants of residential facilities or vice versa
- liaising with the council or the collection contractor on waste management issues.

Conditions of consent may require a development to comply with the submitted and approved waste management plan, including requiring the employment of a caretaker. In large developments, active caretakers are vital for effective ongoing management.

## Case Study 2: High-rise mixed-use development with a problem waste collection service

### The property

Address Ultimo

Development: Mixed-use residential flat development

Municipality: City of Sydney

This mixed-use development consists of a single building with a total of 133 units as well as some retail and commercial premises.

### Residential waste services

A single chute is provided for waste. Access to the chute is from a bin storage and service room on each floor. The room is also used for storing two 240L bins for recycling. The chute empties directly into an 1100L bin which is changed on average twice a day. Residents do not have access to the basement waste chute room. Seven or eight 1100L bins for residential waste are collected twice per week by the City of Sydney.



Bin storage and service rooms on each floor containing the chute hopper and two recycling bins in a mixed-use development.  
Photo: Andrew Quinn

### Commercial waste services

A room is provided for commercial premises to store their waste. Businesses in the development arrange their own waste collections so the commercial waste room features bins from several waste contractors.

### Waste collection

Bins are placed in the loading dock at the rear of the building ready for collection. Collection vehicles pull up in the street and take bins directly from the loading dock.



Collection point in the loading dock at rear of the mixed-use development Photo: Andrew Quinn

### **Ongoing management**

Facilities management regularly arranges for commercial and retail tenants to clean up the commercial waste room. A cleaning bay, with hot and cold water, is also located at the back of the dock for cleaners to wash out bins.

### **Security and safety**

The development is entirely secure and includes a roller door between the loading dock bin storage area and the inside of the building. Cleaning staff transfer bins to the collection point and promptly return them after the collection.

### **Other waste services**

The building also features collection bins and services for other waste types, including mobile phones, household batteries, fluorescent lights, e-waste and used clothing. Two 660L bins are provided for e-waste and these are collected every two or three months.

Building management has found that the e-waste collection reduces instances of dumped waste and mitigates scavenging of e-waste from bins. Batteries are collected in a 60L bin which is collected twice per year. The charity clothing bin is emptied once every two months.



Collection area for problem wastes Photo: Andrew Quinn

### Educational material and signage

Facilities managers use BuildingLink, a building software portal that residents can log into for information on a range of issues, including waste management.

The City of Sydney posters and labels for waste and recycling are provided in the chute room and on bins and doors and in the loading dock. Information is also provided on how to book clean-up services for bulky waste. The council has also provided bins, labels and signage for some of the other waste types.

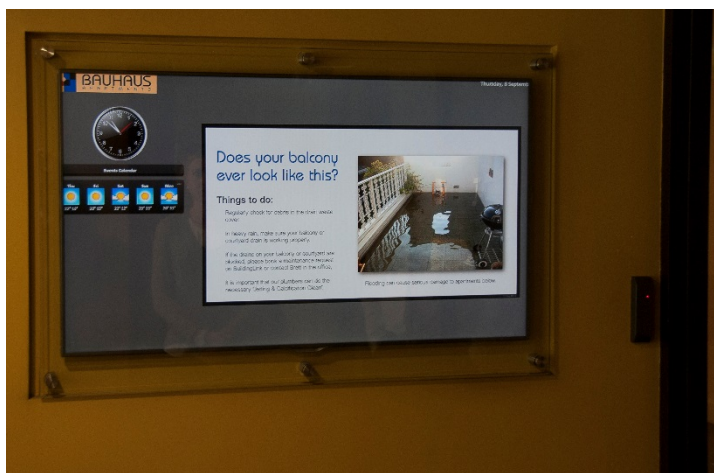

Information screen for residents to see located at the entrance of the building Photo: Andrew Quinn

## 7. New subdivisions and planned precincts

This section applies to subdivisions on greenfield sites to allow the establishment of new housing estates, commonly featuring a range of residential dwelling types from single detached to medium and even high-density allotments. It also covers planned precincts, which may comprise a range of dwelling types and densities as well as mixed retail, community and commercial development.

Waste management services should be developed according to the servicing requirements of the individual property type, as specified in the relevant sections in this guide. To maximise the efficiency of services, the design of waste management services must be integrated into the entire new subdivision or precinct as a whole.

For new subdivisions and planned precincts, a waste management plan (WMP) must be included as part of the Development Application. The WMP should be prepared by a suitably qualified waste or environmental management specialist. A WMP must also be completed for all large scale RFBs and mixed-use developments for example, with a construction value greater than \$5 million. WMPs must include details of the handling of demolition materials, construction waste and recyclables, as well as operation and ongoing management of waste and recyclable materials generated by the development.

For large new subdivisions and town centres the WMP must also consider waste collection and transport logistics. This includes the likely facilities the waste, recycling and organics streams may be sent to and their capacity to accept future waste arising from the new development. The WMP should also consider the development of a small bulking or waste transfer stations and community recycling centres to service the new community.

To ensure better practice outcomes, early consultation with council engineers, planners and waste managers regarding specific council waste management requirements is also essential.

### 7.1. Key considerations

New subdivisions and planned precincts can incorporate a range of dwelling types, land uses and densities. In some instances, laneways, private roads and shared access may be incorporated, limiting the public street frontage available for servicing the subdivision or precinct as a whole.

#### In designing new subdivisions and planned precincts it is important to:

- consider whether waste systems can accommodate the storage and handling requirements of the total development
- provide clear and secure separation of residential and commercial waste facilities
- ensure enough public street frontage to support presentation of bins at the kerbside (this can be particularly difficult with narrow lots)
- ensure the width and alignment of public roads, internal roads and/or rear laneways are sufficient to support access and movements of waste collection vehicles
- consider whether off-street parking allows for access of waste collection vehicles
- ensure there are transitional arrangements to support efficient waste management as the development is being staged e.g. provision of temporary turning areas for waste collection vehicles.

#### Private roads

Some new developments may feature internal private roads or access roads shared between properties and battle-axe blocks. Where onsite waste, recycling and organics collections are proposed, access driveways and internal private roads need to be designed to support access by heavy rigid class collection vehicles. Council may impose conditions of consent in accordance with Austroads, AS2890.2

*Parking facilities: off-street commercial vehicle facilities* as well as local requirements in relation to minimum road widths and strengths and turning circles.

Where private roads are not designed for heavy rigid class vehicles to access the site, councils may not be able to provide their waste and recycling collection services. As a result, residents may be required to bring their bins to the nearest public road (which may be located up to 200 metres away from their home).

To avoid these issues, early discussion with the council's waste management department to determine how the waste, recycling and organics services will be provided will help in the design of internal private streets and roads.



Photo of an example of excess bin cart distances (Photo: The Hills Shire Council)

In this photo where the private road was not designed for waste collection vehicle, residents are required to wheel their bins up to 157m to the public road for collection. The solution in this case was to build a screened communal bin recess adjacent to the driveway, setback 10m from the public road.

## 7.2. Planning for access and waste collection

New subdivisions offer an opportunity to implement better practice waste management from the outset. In these developments, planning and design should consider road layouts, turning points, collection points and access for heavy rigid class waste collection vehicles for designated or private roads.

### Greenfield sites

Better practice provisions in new subdivisions are:

- a minimum carriageway width of 5.5m allowing for a total width of 8m (face of kerb to face of kerb) which would permit access by heavy rigid class waste vehicles to pass between two cars parked on the street
- properties with public road frontages that allow a minimum 2 x 240L bins with a 50cm space in between for kerbside collection, in an area free from obstructions and tree canopies and not blocking driveway access
- for staged developments where the full length of the road will not be completed as part of initial first stage development temporary turning areas are installed, to ensure waste collection vehicles are able to service the new dwellings without needing to reverse out of the street. Temporary turning areas should meet the council's minimum turning head requirements and be removed when a through road is connected into the next stage of the development.

## Battle-axe lots

In the case of battle-axe lots, the developments should ensure that:

- the width of the access handle is sufficient to allow all bins to be presented for collection without restricting vehicle access and movements
- where space cannot be provided at the access road to store bins waiting collection, the neighbouring lot is able to accommodate sufficient space for a minimum of four bins.

## Laneways

For subdivisions that incorporate waste collections from rear access laneways, it is essential that the following points are fully addressed to support better practice outcomes:

- The council's waste collection vehicles can access the designated collection point safely and easily.
- The collection points are located away from ramps, the street and service infrastructure, such as street lighting and poles.
- Laneways are wide enough to accommodate waste collection vehicle movements and required manoeuvring dimensions.
- All residential lots have adequate presentation areas in the laneway to allow for the number of bins required based on council's weekly servicing provisions.
- Waste collection points are located between dwellings and do not obstruct garages or vehicle access.
- Bin presentation areas are a minimum 2m wide and 0.75m deep.
- Collection points are located away from any overhead wires, street tree canopies, building awnings and overhangs and other structures that can impede the operation of waste collection vehicles.
- The length of laneways is limited, and curvature minimised to ensure waste collection staff can maintain appropriate sight distances to view any potential obstructions. These could restrict access or otherwise prevent the collection vehicle from performing a safe and efficient service.
- Where side-loading vehicles are used, waste collection can occur from one side of the laneway.
- Where waste is collected from both sides of the laneway, the property setback and carriageway is wide enough to accommodate waste collection vehicles.

Not all councils allow bins to be presented in rear lanes, so where this is proposed, check with the relevant council early in the design stage.

Figure 14 Typical laneway plan

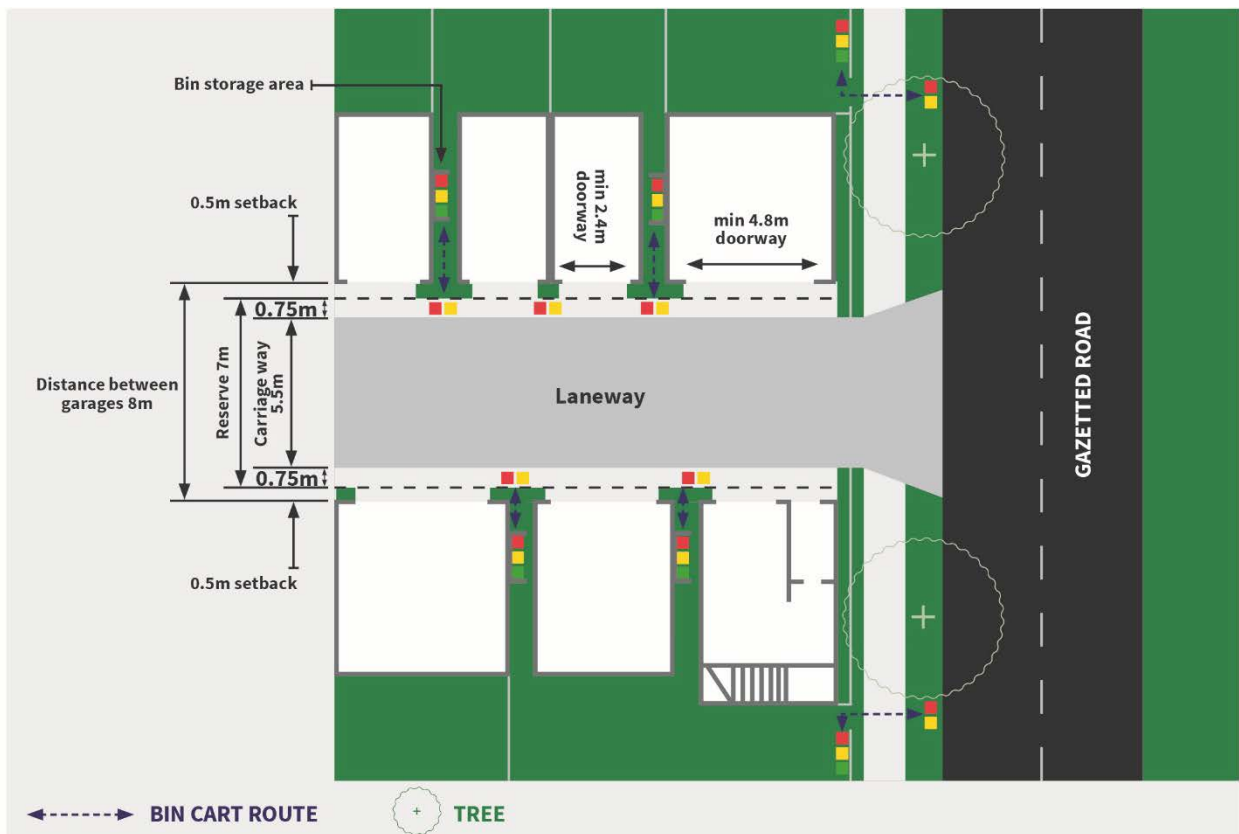

Where bins are serviced in laneways and there is limited road reserve, one-way traffic movement and a 'No parking' requirements should be considered.

## Waste types and handling methods

In determining waste handling and storage requirements in developing the DA, consideration should be given to:

- the proposed location of residential and commercial properties within the development
- the likely retail and commercial mix and the types of waste generated (Refer to **Appendix F**)
- the number of residential dwellings and the quantity of waste, recycling and organics generated by the residential component, including the number and type of recycling/organics bins required (Refer to **Appendix F**)
- the waste infrastructure that will be required to separately manage commercial and residential waste – for example, commercial units may generate large quantities of cardboard that cannot be accommodated in mobile bins
- the type of services offered by council and type of waste collection vehicles they use.

## 7.3. Waste management options

In addition to the requirements outlined in Section 2, better practice waste management in greenfield sites or precinct developments must ensure:

- each residential property and commercial unit has equal, safe and efficient access to a waste and resource recovery service and that the systems installed meet the needs of the property type – for example, waste systems required for townhouses and villas are different from those for high-rise residential buildings
- commercial waste, recycling and organics systems are designed to minimise impacts of noise and odour on residential dwellings



- that for large developments (over 1,000 units) installation of advanced waste collection systems are considered (refer to **Appendix D**).

The waste servicing of the commercial properties in mixed-use developments may be a source of noise complaints from residents living nearby. These commercial services are often carried out by private waste collection contractors before 6am or after 11pm. Disturbance to residents from servicing of bins needs to be fully addressed in the early design stage. Where precinct developments with mixed uses are proposed, the local council may place restrictions on times when commercial waste collections can occur on designated roads as part of the consent conditions.

## 7.4. Onsite collection considerations

If onsite waste collections are proposed, the site plan and layout must consider how waste collection vehicles can access and move around the development. Roads, streets and driveway access throughout the development should be designed and constructed so that waste collection vehicles can drive on them safely and without causing damage.

Consideration needs to ensure that:

- road geometry and road strength can withstand heavy rigid class collection vehicles
- overhead clearances allow heavy rigid class vehicles to pass and operate
- T-heads, turning circles, cul-de-sacs and other vehicle manoeuvring areas are designed to allow waste collection vehicles to safely use them with a minimum amount of reversing required (access and turning circle requirements are discussed in Appendix H)
- buildings and other structures do not extend over roads or corners where they may be struck by waste collection vehicles.

Property managers must also enforce no parking rules on private access roads and turning areas to allow waste collection vehicles safe and easy access. Some councils may recommend the erection of 'No parking' signs covering certain days of the week on designated roads where parked cars may present access difficulties for waste collection vehicles.

Consideration should also be given to the species of kerbside trees selected so that when they are mature they will not arch over roads and restrict the access of heavy rigid class vehicles.

## 7.5. Kerbside collection point considerations

Suitable waste collection points should be planned early in the design stage and identified on the master plans prepared for the council. Depending on the size of the development, there may need to be more than one collection point and a combination of both kerbside and onsite collection.

If the development includes individual free-standing dwellings that will have kerbside collections, enough space should be allowed at the kerbside adjoining the property for the placement of at least two 240L bins.

Kerbside waste collection services should only be carried out if safe and practical.

Refer to **Appendix B** for more information on kerbside collection points.

## 7.6. Bin storage areas

Each dwelling should be provided with an area to store the required number of bins provided by the council. In precinct developments or large housing estates, more than one communal bin storage area may be required. Depending on the layout of the development and its property management structure, it may be possible to share communal bin storage areas between properties. If this is not appropriate, separate bin storage areas within each property boundary should be provided.

If bins are to be collected from a communal collection point located at the entrance to the development, special consideration should be given to:

- the area's visual amenity

- providing adequate space within the bin storage area for moving and cleaning bins
- how the bins will be collected
- how the bins will be moved to and from the communal collection point.

Collection requirements should be discussed with the relevant council in the early planning and design stages and marked on the DA drawings.

Figure 15 Possible collection options within new subdivisions and precinct developments

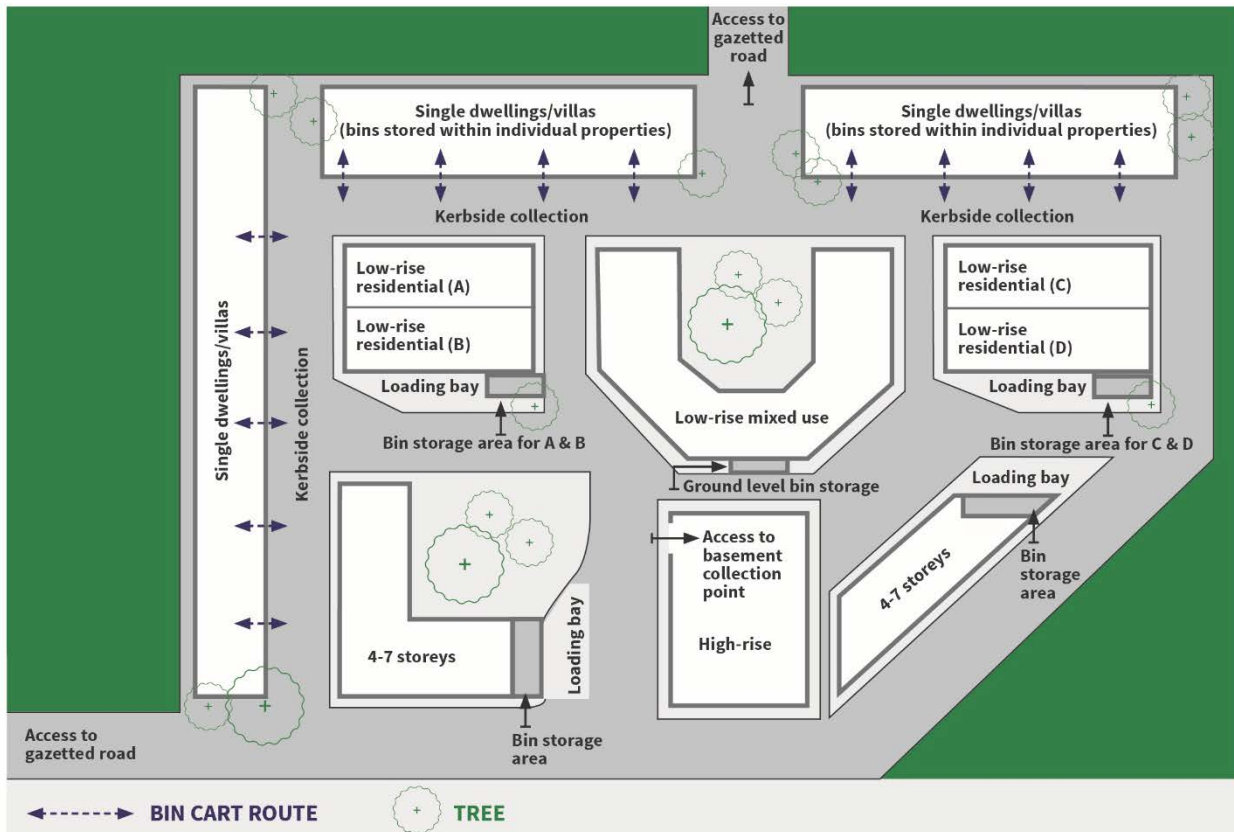

Figure 15 shows onsite collection of bins within new developments that have limited access and no direct street frontage. The development consists of various residential housing types and a mixed-use development.

Bins from the single dwellings and villas located on the northern and western sides of the development are collected from the kerbside of internal roads. Communal bin storage areas have been incorporated into each low-rise and medium-sized development with communal storage areas located adjacent to a dedicated bin loading bay. This enables collection crews to safely park on the property and wheel bins in and out of the adjacent storage area to the waiting vehicle, without the need for kerbside presentation of bins. In this example, waste from the high-rise development is collected on site from a basement storage area.

Figure 16 Example of collection options from a precinct development with limited internal access

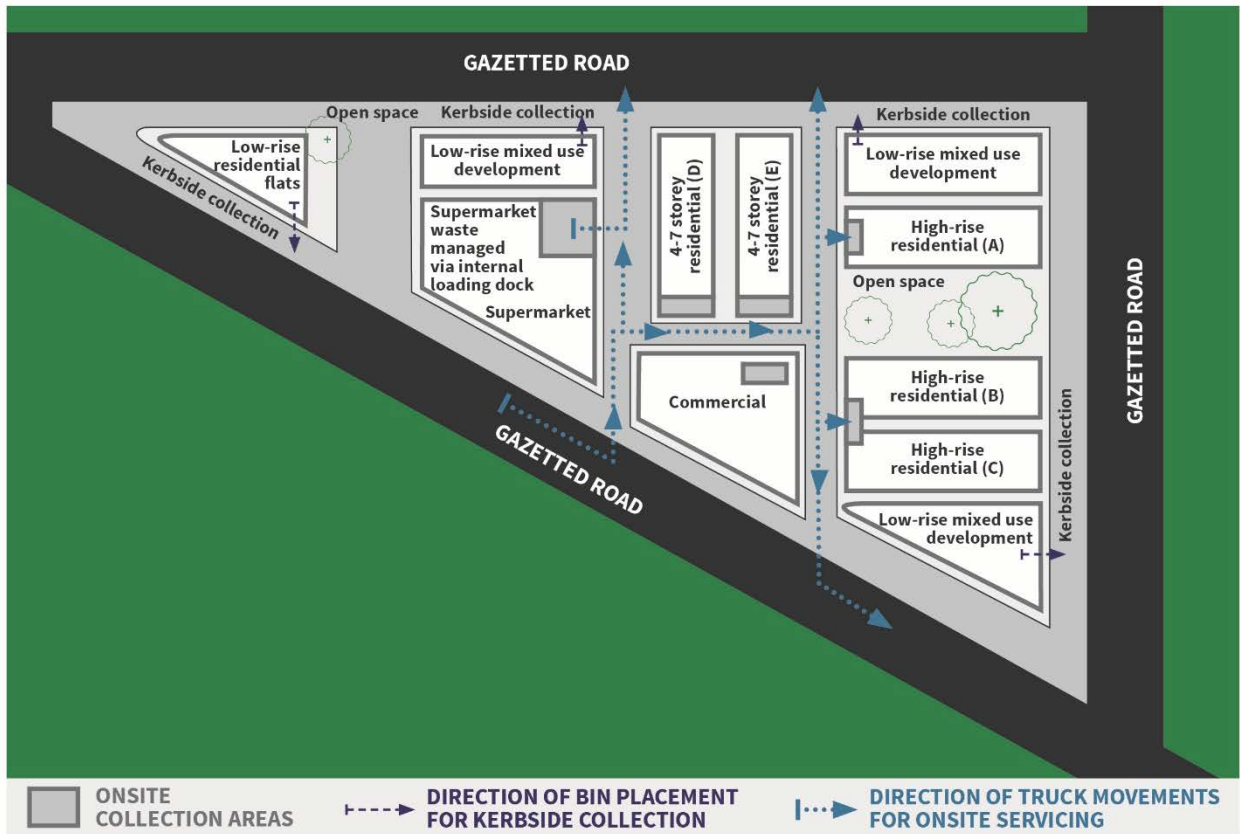

Figure 16 shows the collection of bins from a development that has limited internal access but some street frontage. The development supports a number of different residential, mixed-use and commercial buildings.

Collection requirements are met through a mixture of onsite servicing and kerbside collection of bins. The mixture of on- and offsite collection minimises the movement of collection vehicles along the narrow streets of the development.

Figure 17 Potential problems in new subdivisions and precinct developments

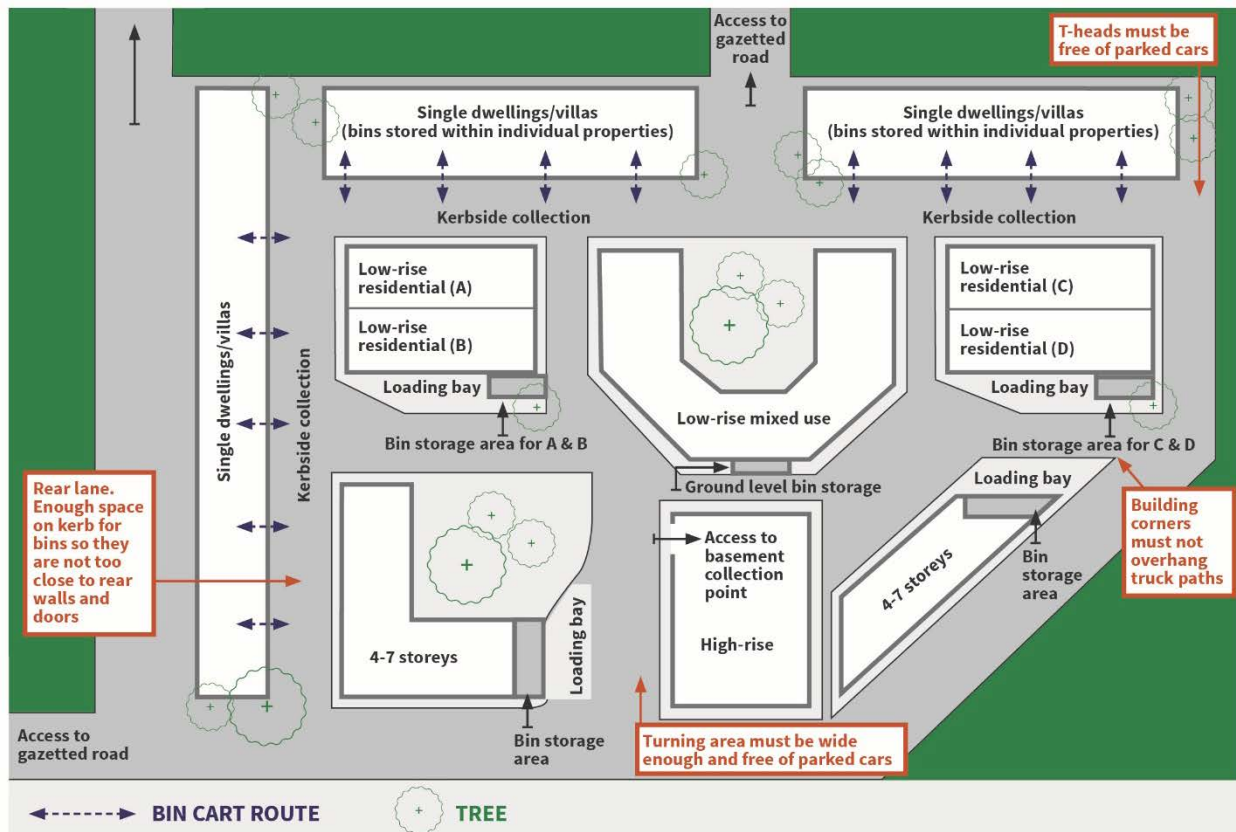

Figure 17 shows some of the potential problems that should be addressed in the planning and design stages in new subdivisions or precinct developments. Additionally, building corners should not overhang vehicle travel paths. In rear lanes, there should be enough space on the kerb for bins to be placed and to enable collection vehicles to lift bins without damaging walls and doors. Turning areas and T-heads should be free of parked cars and wide enough to allow a heavy rigid class vehicle to turn.

## 7.7. Bin pads

At sites where street frontage is limited, it is good practice to include in designs a bin pad to designate bin presentation areas. This option should be considered where councils are concerned with future servicing in laneways. Bin pads can be concreted areas or a stencilled marked area on the ground (as shown in the photos below). This can help ensure waste collections are considered in the design and a clear, level and safe place is made available at the kerbside for the service to occur.

If this option is to be pursued, it is recommended that the council's engineering and strategic planning teams are contacted to ensure the required road widths are taken into consideration in road networks and layouts in the early design stage.



Bin pad made from concrete (Photo: Karina Maloney, Camden Council)



Stencilled bin markings at the kerb (Photo: Camden Council)

## 7.8. Innovative waste collection systems

High-density and greenfield developments (of 1,000+ individual dwellings or units) provide a good opportunity to install advanced waste collection arrangements, such as underground bins or automated waste collection systems (AWCS). These systems allow waste, recycling and organics to be collected below ground instead of having heavy collection vehicles driving through residential areas. These systems are particularly attractive in greenfield sites and large precinct developments where there is limited existing infrastructure both above and below the ground.

Refer to **Appendix D** for more information about AWCS.

Automated waste collection system (Photo: Envac Australia)

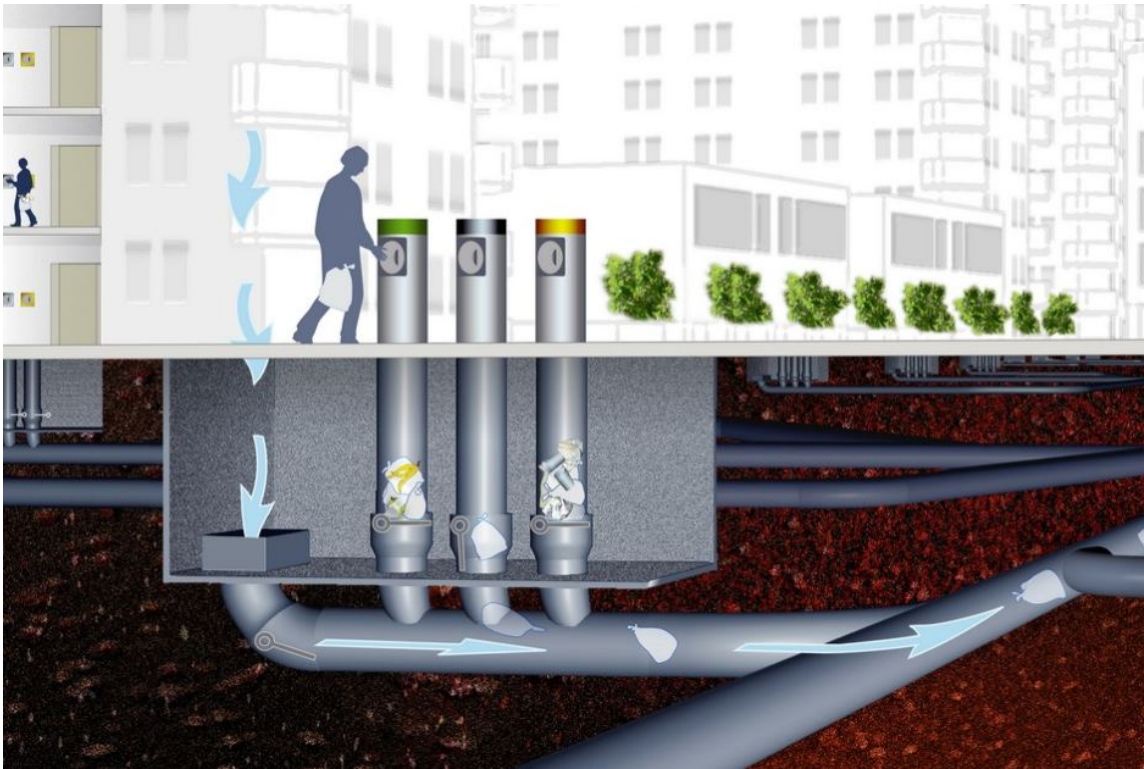

First AWCS installed in Australia (Photo: Sunshine Coast Council)

## 7.9. Circular economy principles in new developments

The circular economy keeps products in use for as long as possible, maximising the value of resources and minimising waste. Best practice waste management is a key component of the circular economy, along with other important aspects which work together to enable stronger environmental, social and economic outcomes, compared with linear economy solutions.

In addition to the design principles detailed in this document, new developments have two opportunities to encourage the transition to the circular economy:

### 1. Increase the use of recycled materials in the construction phase of new developments.

Increasing the use of recycled materials will stimulate demand for recycled products in the region. Strong demand increases product value and promotes further resource recovery, which results in job generation and related benefits.

**2. Design community recycling, re-processing and re-use hubs so that they become part of the social fabric of new communities.** Re-use hubs can be designed into large scale developments and are places that the community can share tools, re-use, repair and recycle products. These hubs help maintain the value of products during product life and recycle and reprocess them into new products at end-of-life. Re-use and repair hubs within new developments will stimulate the re-use and repair of consumer goods such as electronics, clothing, shoes and furniture. The community will see the first-hand benefits of the circular economy through longer-lasting and less expensive goods and local job generation and reduced waste volumes.

For further detail on circular economy principles and how they can apply to new developments and precincts, please refer the [Circular Economy Policy](#)<sup>7</sup>.

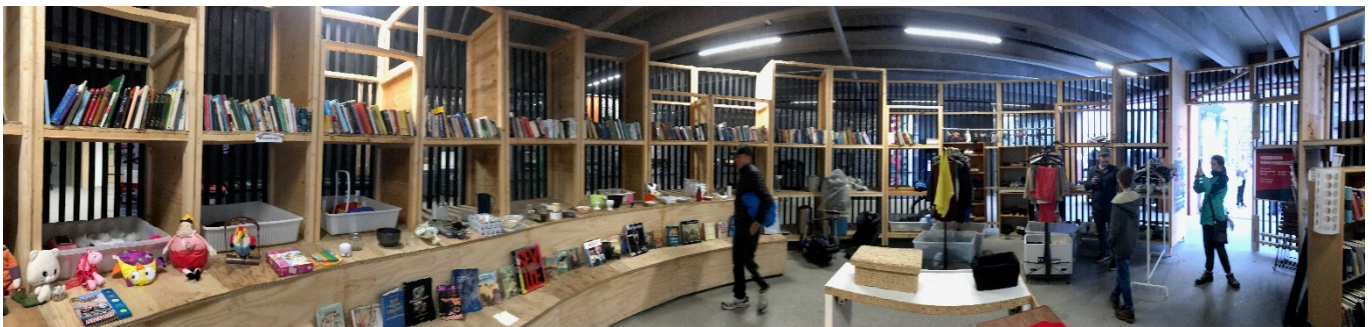

Example of a re-use shop within a residential development in Copenhagen (photo Carrie Hamilton)

<sup>7</sup> [www.epa.nsw.gov.au/your-environment/recycling-and-reuse/response-to-china-national-sword/circular-economy-policy](http://www.epa.nsw.gov.au/your-environment/recycling-and-reuse/response-to-china-national-sword/circular-economy-policy)

# Appendices

## Appendix A: Waste management plan checklist

This checklist can be used to monitor and confirm that the essential issues to achieve better practice waste management have been considered at the right stage during building design.

	Key issues	Completed	Not applicable
<b>Planning Stage</b>			
<b>A</b>	<b>Initial planning</b>		
A1	Have you consulted the council to find out about the waste, recycling and organics collection services available, the bin types and collection vehicles used, and identified future service requirements?		
A2	Has onsite collection (recommended for medium- and high-rise RFBs) been discussed with council?		
A3	Have you considered using recycled materials in your construction?		
<b>Design Stage – to be shown on drawings and Operational Waste Management Plan (WMP)</b>			
<b>B</b>	<b>Separation and Storage of waste, recycling and organics</b>		
B1	Does each residential unit have space inside to store at least two days segregated waste, recycling and organics?		
B2	Have the capacity and type of waste, recycling and organics, bins been estimated based on generation rates?		
B3	Does the bin storage area accommodate the number and type of bins required for the building including space for access and manoeuvring?		
B4	Is the communal storage area suitably enclosed and covered to protect from inclement weather?		
B5	Have you included an appropriately sized communal repair hub, with accessible power?		
<b>C</b>	<b>Storage of other materials</b>		
C1	Has space for residential bulky waste storage been allocated within the development?		
C2	Has sufficient space for communal worm farms or composting facilities been located within the site?		
C3	Has provision for problem wastes been considered in the development?		
C4	Has a space been allocated for collection of <i>Return and Earn</i> containers?		
C5	Has space been allocated for other materials such as e-waste, household batteries, polystyrene or clothing?		
<b>D</b>	<b>Storage location</b>		
D1	Are all residents located within 30m of bin storage areas (not including vertical space)		
D2	Are bin storage areas located in a high pedestrian traffic area?		
D3	Are bin storage areas out of sight or well screened from adjacent dwelling units, surrounding buildings and the street?		



D4	Are the temporary handling areas for a council wheel-in and wheel-out service located within 10m of the layback from the nominated collection point?		
<b>E</b>	<b>Waste collection points: kerbside</b>		
E1	Are kerbside collection points clear of intersections, roundabouts or traffic-calming devices and busy arterial roads?		
E2	Is a heavy rigid vehicle able to safely and easily access and exit from the collection point? (consider also trees, overhanging buildings and low overhead powerlines)		
E3	Can bins be presented for weekly collection in a single row at the kerbside (without blocking footpaths or driveways) and with a minimum space of 50cm between bins?		
E4	Is there step-free access between bin storage areas and collection points?		
E5	Is the collection point located to reduce any noise impacts on surrounding residences?		
<b>F</b>	<b>Waste collection points: onsite (if services provided)</b>		
F1	Have onsite collection point(s) been identified so that:		
	a) collection vehicles will not interfere with access by other road users during collections?		
	b) collection vehicles have safe access to collection points and adequate clearance, manoeuvring and turning space throughout the building or site?		
	c) collection vehicles have no (or minimal) need to reverse?		
	d) there is clear vision of oncoming traffic as collection vehicles leave the property?		
	e) collection point(s) are located on a level surface away from gradients and vehicle ramps?		
F2	Are access driveways of correct strength to support heavy rigid vehicles?		
F3	Are access driveways and internal roads designed in accordance with AS 2890.2?		
<b>G</b>	<b>Transfer of bins to the collection point</b>		
G1	Is the transfer route a minimum of 2.5m wide and made of a hard surface?		
G2	Is the bin transfer route free of steps and excessive gradients?		
G3	Is the travel distance and transfer grade suitable for the bin size and capacity? [see Appendix B]		
<b>H</b>	<b>Waste management equipment</b>		
H1	If a waste chute and/or recycling chute system is planned, will the room the chute dispenses into have restricted access for residents?		
H2	Are the bin storage and serving rooms allocated on each habitable floor designed to comply with BCA and be fire-rated?		
H3	Are bin storage rooms large enough to store at least two days of recycling (where applicable)?		
H4	Has space been allocated to store and operate waste management equipment, such as bin lifters, waste compactors, spare bins, bin trolleys etc?		

H5	Are chutes and compaction equipment designed in accordance with the requirements of the BCA?		
<b>I</b>	<b>WHS</b>		
I1	Has a preliminary risk assessment and hazard analysis been carried out on the proposed waste services and design layout?		
I2	Has the design been modified to eliminate or minimise wherever possible the identified risks?		
<b>J</b>	<b>Noise</b>		
J1	Has the development design included measures to minimise noise associated with the use and servicing of the waste management facilities?		
<b>K</b>	<b>Odour</b>		
K1	Does the design incorporate ventilation for enclosed waste storage areas that complies with the relevant codes and standards?		
<b>L</b>	<b>Hygiene</b>		
L1	Have storage areas been designed to prevent the entry of vermin?		
L2	Are there facilities for cleaning and draining bins in communal storage areas?		
<b>M</b>	<b>Amenity</b>		
M1	Does the design of waste storage areas blend in with the development?		
<b>N</b>	<b>Security</b>		
N1	Does the design allow easy access to waste service areas for residents while restricting access for non-residents?		
N2	Are bin storage areas including access routes sufficiently lit to allow their use after dark?		
<b>O</b>	<b>Signage and education</b>		
O1	Are there suitable waste and resource recovery signs?		
O2	Have requirements for WHS signs been identified?		
<b>P</b>	<b>Ongoing management</b>		
P1	Will a building manager/caretaker and/or gardener be employed to look after waste, recycling and organics?		

## Appendix B: Collection services and vehicles

### Collection services

This section details the three types of collection services typically offered by councils. Proponents should contact council early in the planning stages to find out what services are available for the development.

#### Kerbside collections

Kerbside collections are when the waste or recycling truck collects the waste from the kerbside of a designated public road and council, or its contractors, are not required to enter private property.

**Table B1.1** Pros and cons of kerbside collections

Pros	Cons
Can be a quick and efficient method for servicing bins.	Large numbers of bins at the kerbside can affect building and street amenity.
May be easy for residents and caretakers to take bins to the kerbside	Servicing bins at the kerbside, especially on busy narrow streets, can cause traffic congestion.
Removes the need for onsite waste collections which could reduce design and construction costs for a development.	Collection vehicles forced to stay for long periods in suburban streets to service bins can affect traffic sightlines and visibility, especially around schools and shops, increasing the risks of traffic collisions and compromising pedestrian safety.
Can adapt to future changes in the type of collection vehicles used by the council.	The use of a caretaker or council contractor to move large numbers of bins to the kerbside and returning them to the bin storage area can increase the cost of waste services for residents.

#### Design considerations

Kerbside collections should only happen where there is enough space on the kerb for bins to be lined up without negative impacts on building amenity, pedestrian access or traffic flow.

Kerbside collections should include the following design considerations:

- bins fit in a row with minimum 50cm space between them
- bins are within the site's frontage (not impeding driveway or neighbours' lots)
- bins are a minimum 2m away from trees, bus stops, street furniture and road infrastructure
- bins are a minimum 4.2m away from overhanging tree branches, powerlines and other obstructions

Kerbside collections should **not** be located adjacent to the following structures and services:

- intersections, roundabouts or traffic-calming devices
- along arterial roads
- narrow lanes which heavy rigid class vehicles cannot access
- obstructions such as trees, overhanging buildings, under eaves and low overhead powerlines
- walls and garage doors
- 'No stopping' signs or parked cars

Figure B1.1 Kerbside collection bin arrangement

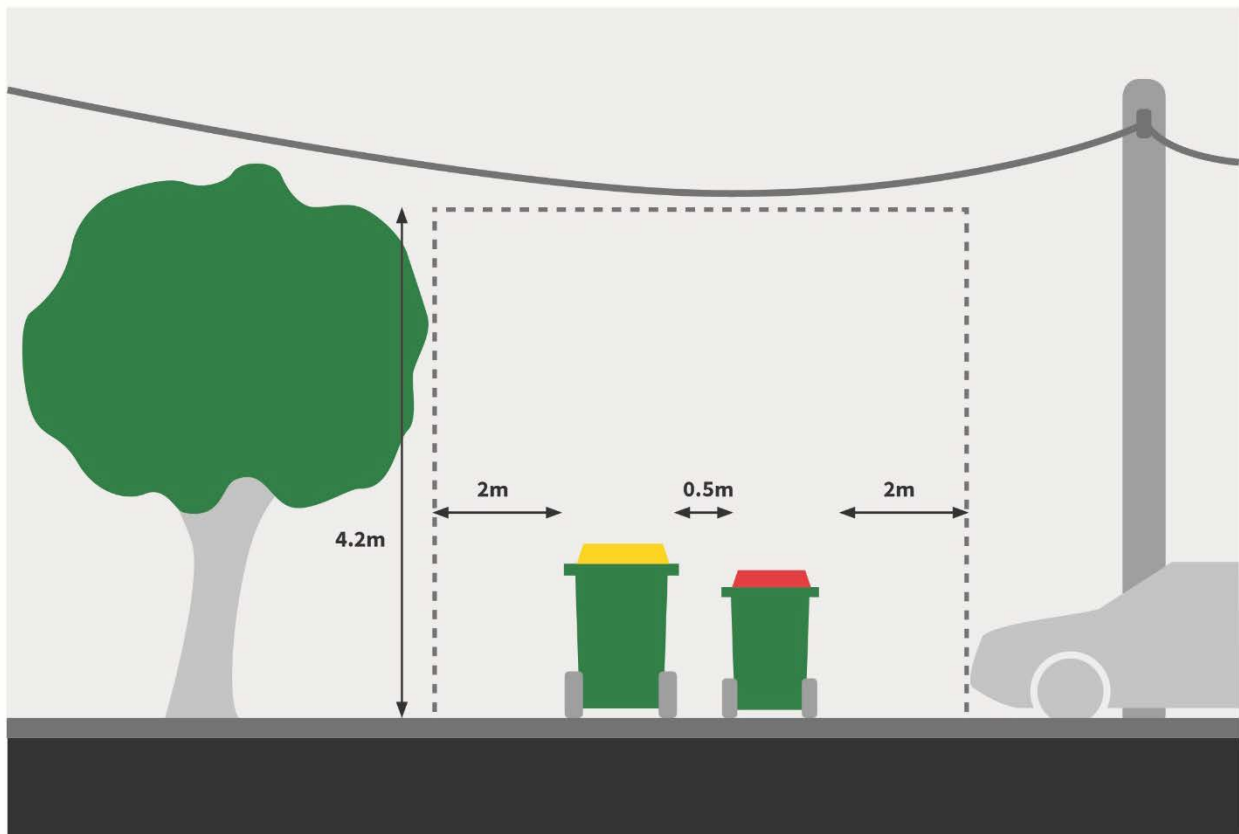

Care should be taken when selecting the location of collection points in one-way streets. Bins must be presented for collection on the passenger side of the street to enable a side-lift collection vehicle to safely empty them (where this vehicle type is planned to be used). Bins placed on the other side of one-way streets cannot be safely collected.

Identifying a suitable collection point is particularly important in developments where:

- a large number of bins are to be collected
- there is limited direct access to the development (for example, a battle-axe block)
- there is limited street frontage
- the development has specialised servicing requirements.

### Council considerations

Local councils should consider implementing and enforcing no standing zones in certain places and at specific times of the day to aid access for collection vehicles and reduce traffic disruptions, particularly in:

- narrow streets or rear lanes where parked cars make servicing difficult
- in T-heads, cul-de-sacs and turning circles.

Council waste officers recommending no standing zones should liaise internally with their traffic engineers to ensure that this approach can be used for the specific DA and the development consent conditions that will be required.

### Wheel-in and wheel-out services

A wheel-in and wheel-out service (also referred to as a 'collect and return' service) is where the council waste collection staff or its contractors enter a site to collect the bins from a bin room or temporary storage area usually at ground level. The bins are taken to the collection vehicle (often parked kerbside)

to be serviced and returned to the bin storage area. This service may be offered for low-rise medium density developments and low-rise RFBs.

Consideration should also be given to indemnity for council waste collection officers entering private property for wheel-in and wheel-out services. Waste officers should discuss the issue regarding indemnity internally with relevant risk officers.

### Design considerations

It is essential that the bin storage areas are located to minimise the bin-carting distance for collection staff. This decreases WHS issues for staff and ensures bins can be carted in a timely manner to reduce traffic disruptions.

It is better practice for the route from the bin storage area to the collection point to be:

- within 10m of a layback from the nominated collection point
- direct and short as possible
- wide enough to manoeuvre the widest bin
- non-slip and free from obstacles and steps
- maximum grade of 1:14 for 240L and 360L bins (or 1:24 where 660 or 1100L bins are used).

Some councils have their own specific requirements and WHS considerations for this type of service, including a maximum length and gradient for the bin-carting route.

Refer to example in Figure 9 section 4.3 for an example of wheel-in and wheel out service.

### Council considerations

Councils should consider inspecting the bin-carting route and the bin storage area to confirm they will be able to service the development. A council inspection could be a condition of consent prior to the issue of the Occupation Certificate for the development. The condition could require that any defects must be addressed prior to any agreement being entered with the council to undertake the service.

## Onsite collection services

These are when the truck enters the development site's boundary to service bins at a nominated collection area.

Onsite collections are preferred where:

- there isn't enough space on the kerbside to place all allocated bins
- the development cannot satisfy kerbside collection requirements
- the development cannot be serviced by a wheel-in and wheel-out service
- lots of bins at the kerbside would delay collection vehicles or present unsafe conditions for vehicle traffic or collection staff
- the council deems collections at the kerbside to be unsafe such as close to schools
- the development is on an arterial road and it will be unsafe for council's collection vehicles to stop.

Onsite collection of waste, recycling and organics bins is considered better practice in larger multi-unit dwelling developments including medium- and high-rise RFBs.

Where onsite collections are available, some councils will not enter private property with their vehicles unless indemnity against liabilities, losses, damages, and other costs arising from the onsite collection service has been provided. To enable onsite collections developers/designers must identify what indemnity requirements are appropriate.

### Design considerations

The following matters are generally applicable:

- Design of the development must ensure that waste collection vehicles can safely enter the site and service all bins.
- Potential site constraints are topography and width of the development.
- Onsite collections can be in purpose-designed bays, lay-bys, at ground level near the entrance to the property or in a basement.
- Design should consider the type of bins and collection vehicles

The onus is on the proponent to demonstrate:

- an improved planning outcome is achieved for the site
- site characteristics do not restrict the development accommodating waste collection vehicles entering and exiting in a forward direction, or emptying the bins
- that the alternative access into the site to the nominated collection point does not compromise public, resident and contractor safety.

Table B1.2 illustrates typical requirements for onsite collection, which may vary between councils.

**Table B1.2** Typical requirements for onsite collection

Design feature	Requirements
Vehicle access	<p>Collection point must be designed to ensure a heavy rigid class vehicle can safely access and manoeuvre within the site. In some cases, universal access keys or remote-controls may need to be provided to collectors to access waste areas.</p> <p>A heavy rigid vehicle must be able to enter and exit the site in a forward direction. The collection point should be located to minimise manoeuvring within the site.</p> <p>The route of travel to the collection point must satisfy the typical dimensions of a heavy rigid vehicle. This also includes adequate clearances for the vehicle. <i>AS2890.2 Parking facilities: off-street commercial vehicle facilities</i> provide typical dimensions and turning circles.</p> <p>The route of travel is to be adequately surfaced and of correct strength to support the waste collection vehicle.</p> <p>The grades of entry and exit routes must not exceed the capabilities of the waste collection vehicle and must comply with <i>AS2890.2 Parking facilities: off-street commercial vehicle facilities</i> for heavy rigid vehicles.</p> <p>A turntable, suitable for the specifications of heavy rigid vehicles, is acceptable to facilitate safe and adequate manoeuvring onsite.</p> <p>Planning design should consider the possible presence of parked cars on access roads.</p>
Waste collection vehicle loading area	<p>A waste collection vehicle loading area must be nominated on the submitted plans and should be:</p> <ul style="list-style-type: none"> <li>• as close as possible to the bin storage area to minimise manual handling</li> <li>• located on the same level as the collection vehicle with bins not placed for collection on elevated loading bays</li> <li>• located so that it does not impede or restrict other vehicle and pedestrian movements during collection times</li> <li>• clearly separated from car parking bays, footpaths and landscaped areas</li> <li>• designed with enough clearance height so that bins can be emptied into the collection vehicles</li> </ul>

	<ul style="list-style-type: none"> <li>located to minimise impact on residents within and adjoining the development site and not located near sensitive land uses or any habitable room or windows.</li> </ul>
Bin-carting route	<p>Ensure that the bin transfer will comply with WHS requirements (refer to Section 2.10).</p> <p>The bin-carting route to the loading area from the storage area should be:</p> <ul style="list-style-type: none"> <li>direct and as short as possible</li> <li>wholly within property boundaries</li> <li>solid, concrete and non-slip</li> <li>a minimum of 2.5 m wide</li> <li>free from obstructions and not include any steps</li> <li>within the bin-carting standards as set out in Table C-2.in Appendix C</li> </ul>
Road surface	<p>If a collection vehicle is required to drive onto a private road (such as a battle-axe block) or private property, the driveway and road must meet appropriate specifications for:</p> <ul style="list-style-type: none"> <li>load capacity</li> <li>width</li> <li>geometric design</li> <li>overhead clearance</li> <li>gradient.</li> </ul> <p>Appropriate heavy rigid class vehicle standards (or the dimensions of the council's waste collection vehicle) should be incorporated into the development design, including those specified in:</p> <ul style="list-style-type: none"> <li>guidelines and codes administered by Austroads, NSW Roads and Maritime Services and WorkSafe NSW</li> <li>any local traffic requirements</li> <li>relevant Australian Standards, such as AS2890.2.</li> </ul>

### Council considerations: access, indemnity and positive covenants

Where onsite collections are proposed, councils should investigate options for ensuring their waste collection vehicles or those of its contractor have the right to access private property to perform the services for the life of the building.

Councils should also consider any potential risks to their staff, contractors and collection vehicles. In this regard, councils may require an indemnity agreement or deed of agreement be signed by the landowner (including any Owners' Corporation) before they carry out collection services on private property. This should form part of conditions of consent and may be imposed prior to the issue of the Occupation Certificate. This indemnity would release the council or its contractors from any claim in respect of loss or damage to private property resulting from providing the normal collection service.

Councils may also require the development to be burdened with a positive covenant for waste collection services under Section 88B of the *Conveyancing Act 1919*. This provides certainty that for the life of the development (until any future sale) the council (or its contractor) can remove waste from the land on which the property is located. The covenant can still require an indemnity agreement to be entered into.

In preparing the positive covenant, consideration should be given to:

- ensuring it is prepared to benefit the council and its contractor to remove waste
- defining what wastes will be removed
- requiring the landowner (including any Owners' Corporation) to permit the council to enter the land with or without vehicles to remove waste
- requiring the landowner to indemnify the council against any future claim for damage or loss.

## Collection vehicles

### Large collection vehicles

Waste collection vehicles may be side-loading, rear-loading, front-lift-loading, hook or crane lift trucks. Vehicle dimensions vary by collection service, manufacturer, make and model. It is not possible to provide definitive dimensions, so architects and developers should consult with the local council and/or contractors.

The following characteristics represent typical collection vehicles and are provided for guidance only. Reference to *AS2890.2 Parking facilities: off-street commercial vehicle facilities* for detailed requirements, including vehicle dimensions, is recommended.

**Table B2.1: Collection vehicle dimensions**

Vehicle type	Rear-loading	Side-loading*	Front-lift-loading	Hook truck	Crane truck
Length overall (m)	10.5	9.6	11.8	10.0	10.0
Width overall (m)	2.5	2.5	2.5	3.0	2.5
Travel height (m)	3.9	3.6	4.8	4.7	3.8
Height in operation (m)	3.9	4.2	6.5	7.1	8.75
Vehicle tare weight (t)	13.1	11.8	16.7	13.0	13.0
Maximum payload (t)	10.0	10.8	11.0	14.5	9.5
Turning circle (m)	25.0	21.4	25.0	25.0	18

\* The maximum reach of a side arm is 3 m.

Sources: JJ Richards, SUEZ, MacDonald Johnson, Cleanaway, Garwood, Ros Roca, Bingo and Edbro. Figures shown represent the maximum dimensions for each vehicle type.

### Rear-loading collection vehicles

These vehicles are commonly used for domestic waste collections from MUDs and RFBs and sometimes for recycling. They can be used to collect waste stored in mobile bins or bulk bins, particularly where bins are not presented at the kerbside. They are also used for collecting bulky waste.

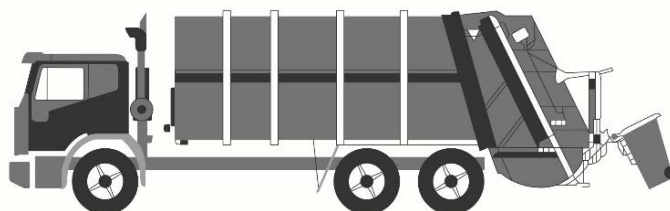

**Rear-loading waste collection vehicle**

### Side-loading collection vehicles

This is the most commonly used vehicle for domestic waste, recycling and organics collections. It is only suitable for collecting mobile bins up to 360L in capacity.



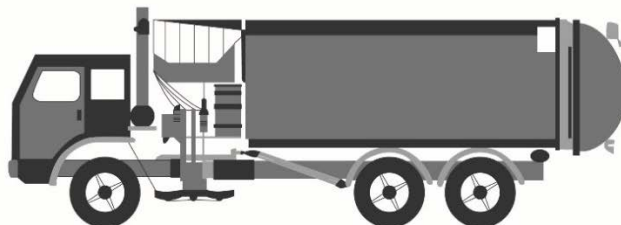

Side-loading waste collection vehicle

### Front-lift-loading collection vehicles

These vehicles are commonly used for collecting commercial and industrial waste. They can only collect specially designed front-lift bulk bins and not mobile bins.



Front-lift-loading waste collection vehicle

### Small collection vehicles

Typically, councils and their contractors operate with large collection vehicles (heavy rigid class vehicles) because they carry greater payloads and allow for more cost-effective collection services. Some councils, or their contractors, may have smaller collection vehicles in their fleet. Early discussion with the council is important to confirm this, but it should not be assumed that the council will have access to small collection vehicles.

The waste management systems and the location of the collection point should always be designed so that the council can provide the standard domestic waste service.

## Appendix C: Bin storage areas – location and design

### Bin storage areas

Identifying the best location for bin storage areas is a balance between convenience to residents, space available, access, noise, security, planning requirements and architectural integration. Bin storage areas must be integrated into the overall design of the development. **Table C.1** outlines points to consider when deciding where to locate waste, recycling and organics bin storage areas and how this assists waste management and resource recovery.

Communal bin storage areas must be located in a safe and convenient place for easy access for all occupants and intended users, including collection staff, contractors, cleaners and caretakers. This will ensure that the bin storage area is used effectively for the life of the development.

Check with the local council for any stipulations of determining overall size of the bin room/area.

**Table C.1:** Better practice location of bin storage areas

Better practice	Reasons
Location of the bins should be convenient to residents.	Conveniently located bins are more likely to be used appropriately.
Bins should be near a high pedestrian traffic area.	Bins are more visible and helps prevent their misuse. Accessing bins will be more easily incorporated into other domestic tasks, such as checking the letterbox or entering and leaving the car park. Bins located in a rarely frequented area of the property tend to attract dumped rubbish and encourage poor practices.
If a wheel-in and wheel-out service is offered, the bin storage area or temporary holding area should be located within 10m of the layback from the nominated collection point.	Manual moving of bins from storage areas to the collection point should be minimised to reduce work, health and safety risks, noise and inconvenience.
The amenity of residents within the development and adjoining the development site is protected and maintained, including storage areas located an appropriate distance from habitable areas.	Noise, odour and general amenity of waste storage and collections should be a consideration in the overall development design.
For habitable areas located directly above or near a waste collection point, consider installing double-glazed windows.	Reduces noise impacts of waste collections on residents.
Bin storage areas should be out of sight or well screened from the street.	Bin storage areas should not affect the aesthetics of the development and should blend in with surrounding buildings and landscape. Locating bin storage areas out of sight from the road also improves safety. Bin storage areas that are too close to the street can be subject to theft, vandalism and illegal dumping.
If collection takes place from the storage area, the storage area should be located at ground level or in a well-designed easily accessible basement.	Collection of bins at ground level or in basements can allow easier, quicker and safer access for collection service providers. It also helps improve street amenity by not having large numbers of bins at the kerbside.
Bin storage areas should not be used for other purposes, such as utility rooms for locating gas meters, power boards or for storing other items.	Non-waste items and utilities can occupy space intended for bins, restricting access for residents and collectors and preventing correct use of waste and resource recovery bins. Utilities may also be damaged during collection or cleaning of bins and even present safety and fire hazards.
Location of storage areas should not require residents to carry waste and recyclables more	Storage areas that require residents to travel long distances to dispose of their waste, recycling and organics are

than 30m from their home unit (not counting vertical space).

inconvenient and can result in poor resource recovery behaviour and misuse of bins. They also make it particularly difficult for elderly and disabled people to use this essential service.

Where the collection point is in the basement, a minimum basement height of 4.5m is necessary to allow a heavy rigid class vehicle to perform the services.

Collection vehicles require overhead lifting room



Bin storage with screening and easily accessed, clearly separated waste and recycling bins (Photo: Penrith City Council)

## Detailed design guidance

Good design of bin storage areas can help deliver better practice and improve resource recovery in residential buildings. The following provides a list of good design for better practice.

### Storage room capacity

To allow for access, manoeuvring, cleaning and maintaining all bins:

- provide an extra 30% of the footprint of each waste container to the overall size of the store room/area
- provide 50cm between all bins allocated for the development and ensure they can be placed side-by-side (no stacking).
- minimise potential obstructions and provide a minimum 1.5m aisle.

To allow for future modifications of services, bin sizes and/or configurations, avoid the installation of fixed structures in bin storage areas.

### Design

Bin storage areas must be integrated into the overall design of the development to improve visual amenity. This can be achieved through:

- providing designated rooms or separate bin enclosures
- using similar construction materials as the main development
- screening from public view by a visual barrier at least 1.5m high.

Bin storage areas should have clear information to encourage correct waste and resource recovery behaviours such as:

- signposted door, for example, 'bin storage and service room'
- clear layout and signage regarding waste, recycling and organics provision, services and required actions.

### **Access**

Bin storage areas must be convenient for all users through:

- restricting or deterring access by non-residents
- providing door width of 2.5m in RFBs where bulk bins are used
- allowing access and manoeuvrability of the largest bin and any required waste handling equipment
- ensuring doors, gates or roller doors are durable, self-closing, lockable and able to be opened from both inside and outside the storage area
- providing separate bin storage areas for residents and commercial premises in mixed use developments that can only be access by their intended users.

Bin storage areas should be readily monitored and maintained through:

- ensuring access for cleaners and caretakers (if required) and restricting access to residents
- ensuring the area cannot be viewed or easily accessed by members of the public.



Bin storage with screening, robust construction and washing facilities (Photo: Penrith City Council)

## Construction

Better practice bin storage areas should achieve more than the minimum compliance requirements: Minimum standards for construction are as follows:

- Ensuring BCA compliance, including ventilation. Where required, ventilation system to comply with *AS1668.4-2012 The use of ventilation and air-conditioning in buildings*.
- Ensuring storage areas are well lit (sensor lighting preferred) and have lighting available 24 hours a day.
- Provision of bin washing facilities, including taps for hot and cold water provided through a centralised mixing valve. The taps must be protected from bins and be located where they can be easily accessed even when the area is at bin capacity.
- Floor constructed of concrete at least 75mm thick.
- Floor graded so that any water is directed to a sewer authority approved drainage connection to ensure washing bins and/or waste storage areas do not discharge flow into the stormwater drain.
- Provision of smooth, cleanable and durable floors and wall surfaces that extend up the wall to a height equivalent to any bins held in the area
- Ensuring ceilings are finished with a smooth-faced non-absorbent material capable of being cleaned.
- All surfaces (walls, ceilings and floors) finished in a light colour.



Bin room with an area for cleaning bins, including hot and cold water tap, drain and barrier to prevent water spilling over, and a roller door to access the room (Photo: Andrew Quinn)

## Bin-carting routes

For safety and ease of manoeuvrability, the distance required for homeowners, building managers and caretakers to wheel bins to their collection point must be the minimum achievable. No steps or kerbs are allowed in the path for wheeling bins to the collection point.

Table C.2: Bin-carting design standards

Bin capacity	Up to 360L	660L – 1100L	More than 1100L
Maximum distance	30m	5m	3m
Maximum surface grades	1:14	1:24*	1:30
Steps or kerbs	None	None	None

\* Reduced gradients of 1:14 may be considered when bins are moved with the assistance of a bin tug device

Where the bin-carting route from the storage area to the collection point exceeds these distances or a large number of bins need to be moved around the site, such as in large developments, a dock leveller, bin lift or a tow tug device may be used.

Refer to **Appendix G** for information on mechanical aids to move bins.

## Appendix D: Other waste collection technology

High density greenfield or precinct developments may provide an opportunity to install advanced waste management options such as:

- automated waste collection systems
- underground container systems.

Developers considering these must discuss this with council early in the design stage.

### Automated waste collection systems

#### What are they?

Automated waste collection systems (AWCS) also known as 'pneumatic' or 'vacuum' systems are a technology that exists in many cities overseas. These systems consist of networks of underground pipes that use negative air pressure to transport waste and recycling along a pipe network to a centralised collection point. This can be up to 2.5km away from the building. From here a waste collection vehicle hauls the waste away for final treatment.

The system is fully sealed, quiet and helps eliminate the need for bins and manual handling of waste. It also helps reduce the number of waste collection movements and can be aesthetically pleasing.

#### When might AWCS be used?

These systems are better suited in high density developments such as town centres or planned precincts where a number of buildings are proposed. AWCS could be considered in the following development types:

- residential flat developments with at least 1,000 units
- high density greenfield sites where it is cost-effective to lay the underground pipe network without interference from existing pipes and other infrastructure
- high density precinct developments comprising a range of building types (residential and commercial) and where economies of scale can be maximised.

Automated waste collection is used in over 100 cities around the world. The first application in Australia planned for the Queens Wharf project in Maroochydore on the Queensland Sunshine Coast.

#### Costs

AWCS require more capital investment than traditional chute systems. However, their benefits can outweigh the costs, particularly in certain locations such as where access to heavy rigid class vehicles is restricted. Space and cost savings can be made from not having several communal bin storage areas and basement heights to allow for heavy rigid vehicles to enter. A cost-benefit analysis is recommended to determine the viability and benefits of installing these systems.

Potential benefits include:

- fewer or no waste collection vehicles at individual households or buildings with collections occurring at a central location off- or on- site or away from residential buildings
- commercial waste can be included in the system, further reducing the overall footprint or need for waste storage areas and waste collection vehicle movements
- lower wage, fuel and vehicle costs, decreased carbon dioxide emissions, noise and traffic congestion from having fewer waste collection vehicle movements
- increased safety and amenity for residents, including reduced odour, noise, spillage and vermin
- less need for waste management equipment, such as waste chutes, compactors and bins
- building cost and space savings from not having bin storage areas.

Figure D-1 AWCS attached to several medium- and high-rise RFBs (Source: Envac Australia)

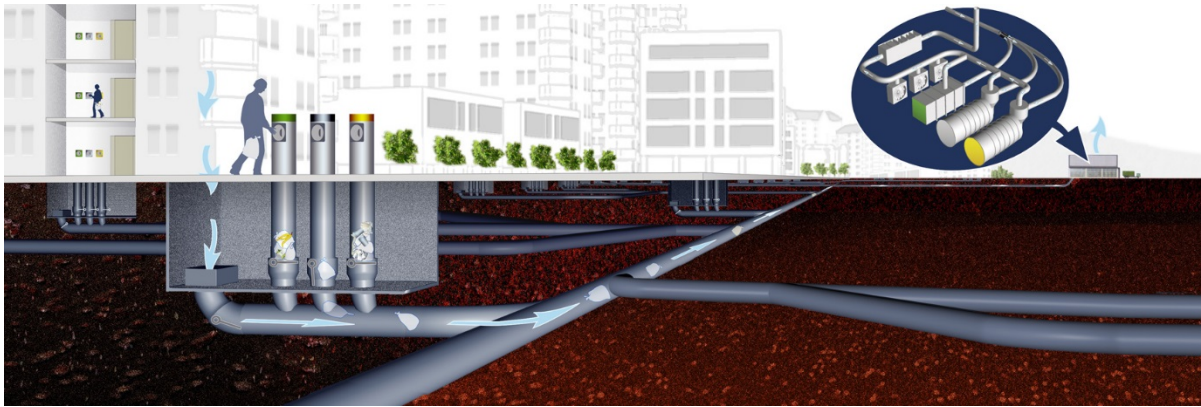

## Underground bins

Underground systems store waste below the ground in bins on a platform that raises to the street level. Disposal inlets sit above the ground for people to deposit waste into. They can be particularly useful where storage space for individual household bins is not available or there is no easily accessible collection point for each dwelling. Underground bins can also be used in busy town centres as street litter bins. Underground bins are available in a range of sizes (up to 1300L).

Underground bins have the following advantages:

- They allow for large waste storage capacity.
- They can be configured for different waste streams (recycling, general waste, organics) or used as a general street litter bin.
- They have a small above-ground footprint.
- Waste stored underground improves amenity by reducing odour and vermin.
- Less collections mean fewer waste collection truck movements in residential streets
- They can make waste collection easier where space for bin storage is restricted.
- Access can be restricted using a key control panel.

Other considerations:

- To service underground bins, power to operate the hydraulic lift must be supplied from onsite mains or from the waste collection vehicle.
- Some underground bins may be able to be serviced by council's standard waste collection vehicles. This should be checked with council in the early planning stages
- Heavy vehicle access and safe servicing of bins are key issues when deciding on suitable location of underground bin systems.





Example of an underground bin system in Sydney used by the residents living in residential flat buildings in the surrounding area  
(Photo: Andrew Quinn)

## Appendix E: Treatment and management of food waste

Food waste can make up 70% of the average residential bin and is a highly recyclable product when source separated. When recycled it can be used to produce valuable fertiliser and reduce the amount of waste sent to landfill. There are several systems that can be used to dispose of and recycle food waste.

### In-sink food waste disposer units

Kitchen food waste disposal units (FWDs) (also known as 'sink macerators') are mechanical appliances installed under the kitchen sink and connected to the drain. Householders feed food waste into these units which then grind and dilute the food waste with tap water and send it into the sewerage system.

Sydney Water discourages their use in RFBs. Some local councils also do not support the use of this technology due to the increased load it places on the sewerage system and because this disposal method does not support council's resource recovery objectives.

The advantage of FWD units is that food waste is conveniently disposed of down the kitchen sink. This diverts food waste away from the solid waste stream and landfill if there is no alternate food or food and garden collection service.

FWDs are not the preferred method for organics disposal currently due to the following reasons:

- increased water use for flushing the food waste
- increased energy use to run the appliance
- higher wastewater services costs to customers due to the additional organic load on the sewer system
- increased disposal of fats and oils in sewers, which can harm the environment around sewerage outlets and contribute to pipe blockages.
- limited resource recovery

**Kitchen food waste disposal unit**

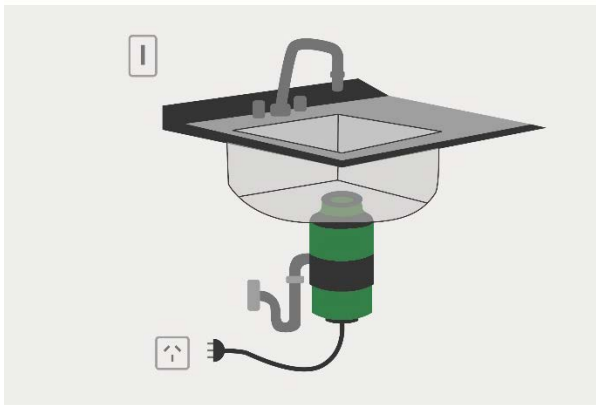

Many of these disadvantages could be overcome if the in-sink food waste disposal units drain to a centrally located storage tank onsite which can be pumped out / collected for processing offsite at a composting facility or anaerobic digester.

Developers considering installing in-sink FWD units discharging to sewer should first:

- consult with the local council and the local sewerage authority to establish whether these units are permitted
- liaise with the council to investigate what garden and/or food organics collection service will be available to the development now or in the foreseeable future.

There are other technologies for separating and processing food waste also available. These can result in higher resource recovery. They include:

- Kerbside food waste collections – some councils collect food waste in a separate bin or combined in the garden organics bins for processing through a large-scale composting facility.
- Onsite composting and worm farming.
- Food dehydrators - rapidly decompose or dehydrate food waste by heating and agitating the waste for short periods to significantly reduce the volume of the waste. The organic matter can then be collected for offsite reuse or further processing.
- Food macerators – commonly found in commercial premises and with the potential for use in residential buildings, these systems pulp food and store it in a tank at the source. When the tank is full, the contents are collected by truck and taken to a treatment facility, such as an anaerobic digester.

## Onsite composting and worm-farming

### Worm farms

Worm farms or vermiculture systems transform food and other organic material into vermicast (worm compost) and vermi-liquid (liquid extract from a worm farm). Seafood, seafood shells, meat or bones and dairy products are not an acceptable part of the worms' diet and should not be applied to these systems. Worm farms can occupy a small footprint and be located on balconies or in gardens. The worm farm should be placed in a sheltered position to avoid getting too hot in summer.



A typical worm farm (photo NSW EPA)

Worm farms come in different sizes and designs and are sold through hardware stores and often at local government offices. Medium- and large-scale worm farms can service many households and commercial activities. These larger systems need a management process to ensure they are properly maintained.

### Onsite composting

Compost tumblers and bins and compost bays transform food and other organic material into useful soil enhancer (compost).

They are more versatile than worm farms as they can generally process a wider range of materials, including woody garden organics and can be placed in the sun.

Before setting up an onsite composter or a worm-farm system, check with council for any local requirements such as setback distances from property boundaries.

A variety of compost bins and tumblers are available from hardware stores or some local councils. There are also various online resources on how to construct them using recycled materials such as timber pallets. The footprint area requirement for a typical single household compost bin is about 1m x 1m x 1m.



Compost bay (photo NSW EPA)

## Rapidly decomposed or dehydrated food waste

Enclosed machines are available that rapidly decompose or dehydrate food waste by heating and agitating the waste for short periods usually less than 24 hours. Some machines operate with the addition of bacterial starter cultures and all produce a dried output material. Re-wetting this output will restart the usual decomposition process and can potentially pose human health and odour risks.



UTS food waste dehydrator. Photo: Hannah Jenkins

There are various regulations regarding the re-use of the output materials. Where the output is intended for land application, the material can either undergo further treatment at a facility that can lawfully receive

it such as a commercial composting facility or the output can be re-used according to the conditions of an existing Resource Recovery Order and Resource Recovery Exemption.

At the time of publication, three orders and exemptions had been granted by the EPA for rapid decomposition and dehydration machines. The current Orders and Exemptions and a fact sheet on these are [available on the EPA's website](#).

## Macerators

Macerators are grinders that reduce the volume of food waste by turning solid food waste into pulp slurry. This is pumped to an exterior holding tank collected by a licensed contractor and taken to a lawful processing facility (such as an anaerobic digester or commercial composter) or directly applied to land under a Resource Recovery Order and Resource Recovery Exemption.

## Viability of the technology

The viability of these systems and whether they may be suitable for any particular development depends on such factors as the:

- size of the development, number of households and quantities of food waste generated
- presence of retailers and commercial premises and quantities and types of food waste generated
- availability of trained people to manage and operate systems
- availability of suitable space
- willingness and ability to source separate food waste
- availability and cost of food or food and garden collection services to offsite organic processors
- ongoing operation and maintenance requirements of the selected onsite system. For example, the cost of testing outputs so they comply with the requirements of a Resource Recovery Exemption or trade waste discharge to sewer license.

## Food waste in commercial premises

To tackle the issue of food waste generated in commercial premises, the NSW Government offers programs, such as *Love Food, Hate Waste* and Bin Trim.

These programs can help businesses to better understand

- the amount of food waste they generate
- adopt simple and practical actions to avoid food waste
- donate unwanted good quality food to people in need
- recycle any remaining food waste.

Further resources:

- EPA's food waste business [fact sheet](#)<sup>8</sup>
- Contact the EPA for information about the Bin Trim program
- NSW Government's [Love Food, Hate Waste](#) program

---

<sup>8</sup> [www.epa.nsw.gov.au/-/media/epa/corporate-site/resources/waste/reduce-food-waste-business-fact-sheet-160375.pdf?la=en&hash=F826FCD08F59E60001523B7879DA39B79EF707DA](http://www.epa.nsw.gov.au/-/media/epa/corporate-site/resources/waste/reduce-food-waste-business-fact-sheet-160375.pdf?la=en&hash=F826FCD08F59E60001523B7879DA39B79EF707DA)

## Appendix F Waste and recycling generation rates

The figures in Table F2 and F3 should be used for estimating the waste and recycling generation rates for residential properties and commercial units when this information is not available from the local council directly. It is always preferable to contact the council's waste management team or refer to the council DCP to obtain domestic waste and recycling generation rates.

### Allocated domestic waste and recycling generation capacities

The most common waste collection systems in single-unit dwellings (typical free-standing houses) is:

- 120L or 140L red-lid bin for waste collected weekly
- 240L yellow-lid bin for recycling collected fortnightly
- 240L green-lid bin for garden organics collected fortnightly (though councils are increasingly introducing combined weekly food waste and organics collections using these green bins to divert food waste from landfill).

In residential flat buildings, the weekly capacity allocated for waste and recycling differs across councils and is different from that offered to single-unit dwellings. Some councils base capacity requirements on one bin shared between a number of units – for example, two, three or four units per 240L bin for waste. This provides 60L, 80L or 120L per week capacity per unit for waste and a similar method is used for recycling. Some councils provide a different calculation using larger capacities like 660L and 1100L bins. In the first instance, contact the local council to determine the bin allocation per household per week or the waste and recycling capacity calculation used by the council or refer to the relevant council DCP.

Table F1: Waste capacities by type

Bin types	Weekly capacity calculation	Approx equivalent weekly capacity per household
240L	1 per 2 units	120L
660L	1 per 6 units	110L
1100L	1 per 9 units	122L
1 m <sup>3</sup> bin	1 per 8 units	125L
1.5 m <sup>3</sup>	1 per 13 units	115L
3 m <sup>3</sup>	1 per 25 units	120L
4.5 m <sup>3</sup>	1 per 38 units	118L

### Estimated domestic waste and recycling generation rates

The average total generation of waste per unit per week is approximately 8.5 kilograms (kg) per dwelling per week. Of this, about 6.4kg is general waste and 2.1kg is recyclables. The EPA has provided volume-to-weight conversion figures of 0.131 tonnes per cubic metre for uncompacted domestic waste and 0.262 tonnes per cubic metre for compacted domestic waste.

Allowing for variances and increases in waste generation, as a general guide, the allowance for waste and recycling storage RFBs can be calculated using the following figures:

Table F2: Estimated domestic waste and recycling generation rates per week

Apartment size	Waste	Recycling	Organics
1 bedroom or studio	80L	80L	25L*
2 bedroom apartment	100L	100L	25L
3 bedroom apartment or greater	120L	120L	50L

\* this assumes a 7L kitchen caddy for food preparation and food scraps is emptied 3.5 times per week. In addition to food waste there may also be organics waste generated from the maintenance of communal gardens and pot plants.

## Estimated commercial waste and recycling generation rates

The following instructions apply when using the data in Table F3 to calculate waste generation rates for commercial buildings.

- Data has been provided on a 'per day' calculation rate because similar premises types can operate five or seven days per week.
- This data is for general waste and recyclables (paper/cardboard and commingled). The premises may generate other waste types (for example, medical clinics in a shopping centre) and so generation rates for these should also be considered.
- This data is predominantly to be used for calculating waste and recycling generation rates as part of the planning process.
- For premises that have multiple types of facilities (for example, a club that has accommodation, bars, cafes and restaurants or a residential building with a convenience store or an office building with café, gym and childcare), all such facilities must be calculated separately and then volumes generated combined when looking at the bins required, storage size and servicing frequencies.
- As several premise types generate organics (for example, butchers, seafood retailers and greengrocers), the calculations of waste generation and systems should consider if an organics system will be implemented.
- 'Per premises' data is based on the average size for the type of business (approximately 80 m<sup>2</sup>). Where the waste generation areas are larger, a pro-rata increase in waste/recycling generation should be made.
- Consideration should be given for times of peak generation such as when stock is delivered or sale times at retail stores.
- Shopping centres can have a variable tenant mix. Some have large tenancies (used by the major chains), whereas others have a broad range of small tenancies as well as offices, medical centres and a higher percentage of food outlets as opposed to general retail. Therefore, these should be calculated separately.
- The volume calculations do not take into consideration systems that may be used, such as compactors for paper/cardboard or waste.

Table F3: Calculating commercial and industrial waste and recycling generation rates

Premises type	Suggested generation (litres per unit per day)		Comments
	Waste	Paper, cardboard and commingled materials	
Accommodation: non-hotel/motel	10	5	Based on the number of guest rooms with other types of facilities calculated separately. Note: function rooms are based on potential bookings and restaurant data.
Aged care	5	1	Per resident. Kitchen to be calculated as per restaurant. Need to determine if other services are offered. Note that other waste such as clinical waste will be generated.
Cafes	100	120	Based on per 100 m <sup>2</sup> floor space.
Carparks (commercial)	1	1	Based on per 100 m <sup>2</sup> floor space.

Childcare	5	5	Per child
Cultural and recreational services: (museums, theatres, cinemas)	5	10	Based on per 100 m <sup>2</sup> floor space for patrons (seating areas for theatre/cinema). Calculate cafes separately. Calculate office areas separately.
Dry cleaning	15	5	Per premises (80 m <sup>2</sup> )
Food retail: bakeries	240	120	Per premises (80 m <sup>2</sup> )
Food retail: butchers	250	50	Per premises (80 m <sup>2</sup> ). If organics recycling implemented, then 150L may be transferred from waste.
Food retail: seafood	250	50	Per premises (80 m <sup>2</sup> ) If organics recycling implemented, then 150L may be transferred from waste.
Food retail: greengrocers	540	60	Per premises (80 m <sup>2</sup> ) A higher rate needs to be considered for larger premises (based on a pro-rata increase for the 80 m <sup>2</sup> ) premises. If organics recycling implemented, then 300L may be transferred from waste.
Food retail: other	120	80	Per premises (80 m <sup>2</sup> )
Food retail: takeaway (with sit-down area)	500	240	Per premises (80 m <sup>2</sup> ) – day operation only Note consideration must be given to the number of hours or operation.
Food retail: takeaway (food preparation only)	120	60	Per premises (80 m <sup>2</sup> )
Gymnasiums	20	15	Based on per 100 m <sup>2</sup> floor space
Hair and beauty	50	40	Per premises (80 m <sup>2</sup> )
Hotels/pubs (without meals provided at the bar)	50	50	Based on per 100 m <sup>2</sup> floor space. Calculate restaurants separately (including meals served at bar) as well as accommodation (use motel rate).
Licensed clubs (with gaming)	50	50	Based on per 100 m <sup>2</sup> floor space. Calculate restaurants separately (including meals served at bar) as well as accommodation (use motel rate).
Medical	20	10	Per number of doctors' consulting rooms. Need to determine if other services are offered. Note that other waste such as clinical waste will be generated.
Motels	10	5	Based on the number of guest rooms with other types of facilities calculated separately.
Offices	10	15	Based on per 100 m <sup>2</sup> floor space that is used for staff activities (e.g. exclude lobby areas).
Optical	15	25	Per premises (80 m <sup>2</sup> )
Restaurants	400	280	Based on per 100 m <sup>2</sup> floor space
Retail: chemists	20	45	Per premises



Retail: chain stores (clothing, manchester etc.)	5	20	Based on per 100 m <sup>2</sup> floor space. Other facilities such as cafes calculated separately.
Retail: other non-food	50	100	Per premises
Retail: grocery and convenience stores	120	240	Based on per 100 m <sup>2</sup> floor space
Retail: homeware and kitchenware shops	20	120	Per premises
Retail: newsagents and stationery shops	30	60	Per premises
Retail: office-based (e.g. travel agents)	30	40	Based on per 100 m <sup>2</sup> floor space that is used for staff activities (e.g. exclude lobby areas).
Retail: variety gift stores	20	120	Per premises
Schools: pre-school	10	15	Per student
Schools: primary	15	20	Per student
Schools: secondary	20	15	Per student
School: tertiary	10	10	Per student (full time equivalent). Note that other waste such as chemical waste will be generated. Need to calculate other services (e.g. food halls, student accommodation, childcare, gyms), separately.
Showrooms	10	25	Based on per 100 m <sup>2</sup> floor space
Supermarkets	240	300	Based on per 100 m <sup>2</sup> floor space. Larger supermarkets may have a number of recycling streams, so advice should be sought as to what systems will be provided.
Wholesale trade	100	50	Based on per 100 m <sup>2</sup> floor space

Table F3 has been developed using a range of data sources including literature review of other published waste generation data and the results from the *2014 NSW EPA Generator site survey of the commercial and industrial waste stream in the regulated areas of NSW* as well as comparisons to actual waste audit data from a range of commercial types.

## Appendix G: Waste management equipment and bins

All bins and containers allocated must conform with *AS4123.1-2008 Mobile waste containers* and be fitted with the correct colour lid for the waste contained as per *AS4123.7-2006 Mobile waste containers: colours, markings and designation requirements*.

Waste handling equipment, including waste chutes and compactors, must conform to the manufacturers' relevant design and safety standards and meet all council requirements.

### Mobile bins

Mobile bins come in a variety of sizes and are designed for lifting and emptying by purpose-built equipment.

Mobile bins with capacities of up to 1700L must comply with *AS4123.6-2006 Mobile waste containers* which specifies standard sizes and sets out the colour designations for the bodies and lids of mobile waste containers indicating the type of materials they are used to collect.

The most common bin sizes are provided below, although not all sizes are shown. The dimensions are a guide only and differ slightly between manufacturers. Some bins have flat or domed lids and are used with different lifting devices. Refer to *AS4123.6-2006* for further details.

Table G1.1: Average dimension ranges for two-wheel mobile bins

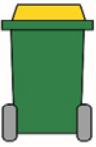

Bin capacity	80L	120L	140L	240L	360L
Height (mm)	870	940	1065	1080	1100
Depth (mm)	530	530	540	735	820
Width (mm)	450	485	500	580	600
Approximate footprint (m <sup>2</sup> )	0.24	0.26–0.33	0.27-0.33	0.41–0.43	0.49
Approximate weight (kg)	8.5	9.5	10.4	15.5	23
Approximate maximum load (kg)	32	48	56	96	Not known

**Wheelie bin**

Sources include Sulo, Single Waste, Cleanaway, SUEZ, just wheelie bins and Perth Waste for two-wheel mobile bins

Table G1.2: Average dimension ranges for four-wheel bulk bins



Bin capacity	660L	770L	1100L	1300L	1700L
Height (mm)	1250	1425	1470	1480	1470
Depth (mm)	850	1100	1245	1250	1250
Width (mm)	1370	1370	1370	1770	1770
Approx footprint (m <sup>2</sup> )	0.86–1.16	1.51	1.33–1.74	2.21	2.21
Approx weight (kg)	45	Not known	65	Not known	Not known
Approx maximum load (kg)	310	Not known	440	Not known	Not known

**Dome or flat lid container**

Sources include Sulo, Signal Waste, Cleanaway, SUEZ, Just Wheelie Bins and Perth Waste

The following front lift bulk bin dimensions are a guide only and may differ slightly according to manufacturer.

Table G1.3: Average dimension ranges for bulk bins over 1700L in capacity

Bin capacity)	1m <sup>3</sup>	1.5m <sup>3</sup>	2m <sup>3</sup>	3m <sup>3</sup>	4.5m <sup>3</sup>	6m <sup>3</sup>
Height (mm)	1000	910–1250	865–1000	1020–1580	1440–2014	1650
Depth (mm)	1000	905–1000	1300–1400	1470–1700	1605–1900	1900
Width (mm)	1400	1805–2010	1830–2000	1400–2010	1800–2010	2000
Approximate footprint (m <sup>2</sup> )	1.4	1.63–2.01	2.4–2.8	2.1–3.4	2.9–3.8	3.8



Bulk bins greater than 1700L

Sources include TORO Waste Equipment, SUEZ, Signal Waste, Perth Waste and ACT Industrial

### Bin lifters

If mobile bins containing waste, recycling or organics must be emptied into bulk bins, suitable equipment must be provided to eliminate the risks associated with manual lifting and emptying. This could include hydraulic, electric or gas strut bin lifters.

The lifting equipment should be fitted with safety features to prevent injury to operators and secured to prevent unauthorised use, particularly by residents.

The cost of procuring and maintaining a bin lifter, and the employment of a caretaker to operate it should be factored into the ongoing management of the development.

Bin lifters are available for a range of bin sizes, including 120L, 240L and 660L.

Waste storage areas must be designed to allow enough space to store and operate the lifting equipment.



Examples of bin-lifting devices

## Bin transporters

In large complexes, such as where several buildings share a common basement carpark or where lots of bins need to be moved around the site from chute rooms to the main bin storage area or collection point, mechanical devices such as a small tractor or tow tug must be used. This equipment will help reduce the risk of injury from transporting bins over long distances.

Specifications of the device and location of where it will be stored must be submitted with the waste management plan.

Hitching mechanisms for 660L and 1100L bins can be fitted to enable cleaners or facilities managers to tow large bulk bins using a tow motor or tractor in small trains.

## Advantages and disadvantages of mobile bins and bulk bins for collecting waste and recycling

Bulk bins are not recommended for collection of commingled recycling. This type of bin can lead to residents misusing the bins, resulting in contamination of the recycling stream. However, a separate bulk bin (with a blue lid) can be used for collection of paper and cardboard only.

**Table G1.4: Advantages and disadvantages of mobile bins**

Advantages	Disadvantages
Mobile bins are generally easy to manoeuvre.	A large number of bins may be required to service the development.
Bins can be numbered and shared between units (in some cases). This may provide a degree of ownership, leading to increased accountability and appropriate behaviour.	A large number of bins requires significant storage and may not be an efficient use of space.
Residents can be responsible for moving bins to and from the collection point in low-rise or medium-rise developments, so less time is required by the caretaker for ongoing management.	A large number of bins require more time for the ongoing management of the system, such as cleaning, maintaining and moving them to and from the collection point.
Mobile bins may be collected from the kerbside where there is enough room to do so safely and efficiently.	Bins placed on the kerbside for collection can reduce amenity and pose risks to pedestrians by blocking pathways. They can also pose a safety risk to collection operators if they are required to manually move bins around cars, trees, poles and other kerbside infrastructure.
Mobile bins are a simple and easy system to use for the collection of waste, recycling and organics.	Residents may leave bins at the kerbside for long periods if a caretaker is not employed.
Encourages participation in resource recovery through co-location of waste, recycling and organics bins.	If there are not enough bins for waste, residents may instead use the recycling or organic bins which can lead to increased contamination.
	Sharing bins between a greater number of units decreases sense of ownership and increases misuse.

**Table G1.5: Advantages and disadvantages of bulk waste bins**

Advantages of bulk waste bins	Disadvantages of bulk waste bins
Bulk bins can help reduce the size of the bin storage area.	Bulk bins can be heavy when full and pose potential health and safety risks if manually moved. There are restrictions on how far bulk bins can be moved: refer to Table C 2 in Appendix C for maximum distance of travel for bins.
Bulk bins look better than a larger number of mobile bins presented at the kerbside for servicing.	Access for safe and efficient emptying of bulk bins may be limited.

Bulk bins can be a simple and easy to use system.

Onsite collection is generally required for bulk bins, which may not be possible in some RFBs.

Bulk bins encourage participation in resource recovery through co-location of waste, recycling and organics bins.

Where onsite collection of bulk bins is the better option, roads, pathways and driveways will need to be engineered for use by heavy rigid class collection vehicles.

Bulk bins allow space for storing unwanted bulky waste (clean-up material) awaiting collection.

The lids on bulk bins can be heavy for some residents to lift and may result in bags of waste being placed at the base of bins.

## Chute systems

Approval must be sought from the local council before committing to any system using chutes and compactors.

### Waste chutes

Waste chutes are vertical tubes that run through each floor of a building to the basement where it empties into mobile bins or bulk bins. Chutes for waste collection are suitable in buildings of four or more storeys.

Where a chute system is proposed for collecting recyclable materials, compaction is not recommended. This is because compacting recyclables breaks glass and causes contamination of paper and cardboard with glass particles.

It is important to follow the manufacturer's advice on compaction ratios. Over-compaction of waste can result in damage to bins, jamming of waste inside the bin and can make them heavy and difficult to move to the collection point.

Figure G2.1 Basement layout in high-rise development

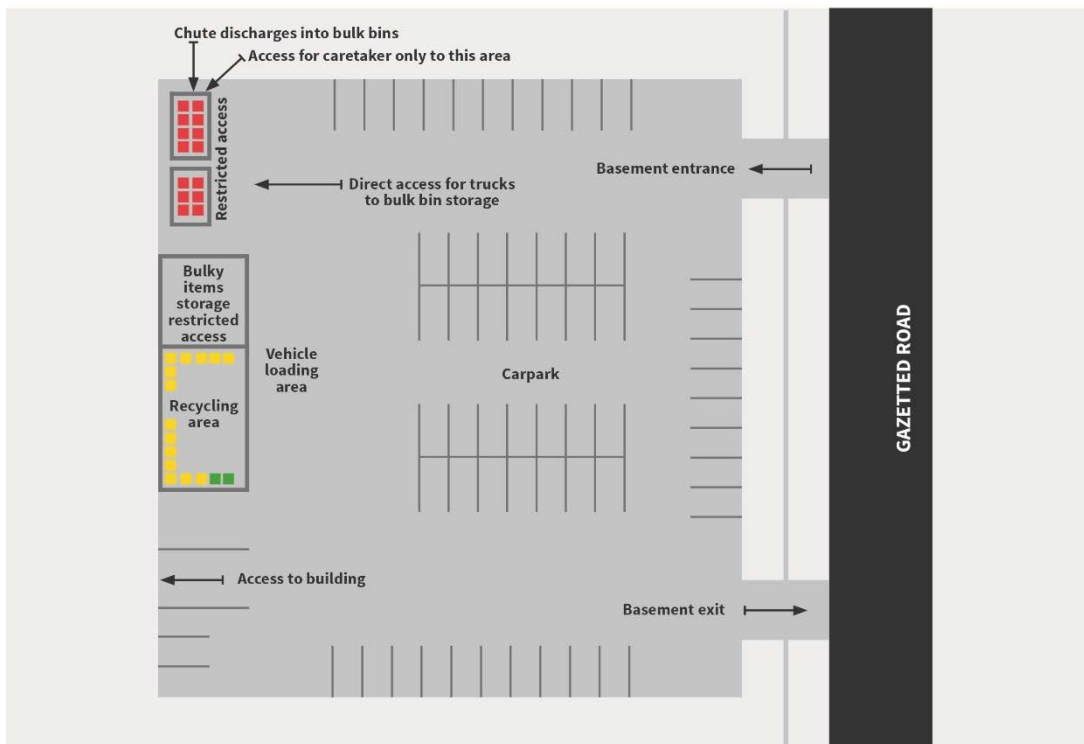

Figure G2.1 illustrates the basement area of a high-rise building which uses both a chute for waste and bin storage and service rooms for recycling on each floor. Onsite collection of bulk bins for waste and recycling occurs in the basement.

Residents do not have access to the basement room containing the chute although they can access the bulky waste storage area and the recycling bins. This arrangement allows collection of the bulk bins using heavy ridge vehicles which can enter and leave the site in a forward direction.

Recycling collection vehicles can also enter the basement and stop directly in front of the recycling bin storage area. Enough space has been provided to undertake the collection without obstructing traffic in the car park. This example assumes recycling bins are wheeled from the storage area to a rear-loading collection vehicle, not a side-lift vehicle. The vehicle then leaves the basement car park traveling in a forward direction.

Similarly, bulky waste can be removed by the waste collection vehicle pulling up alongside the bulky waste storage area.



Waste chute inlet located inside a bin storage and service room on each floor of a medium-rise building (Photo: Andrew Quinn)

Figure G2.2: Cross-section of chute and bin storage and service room system

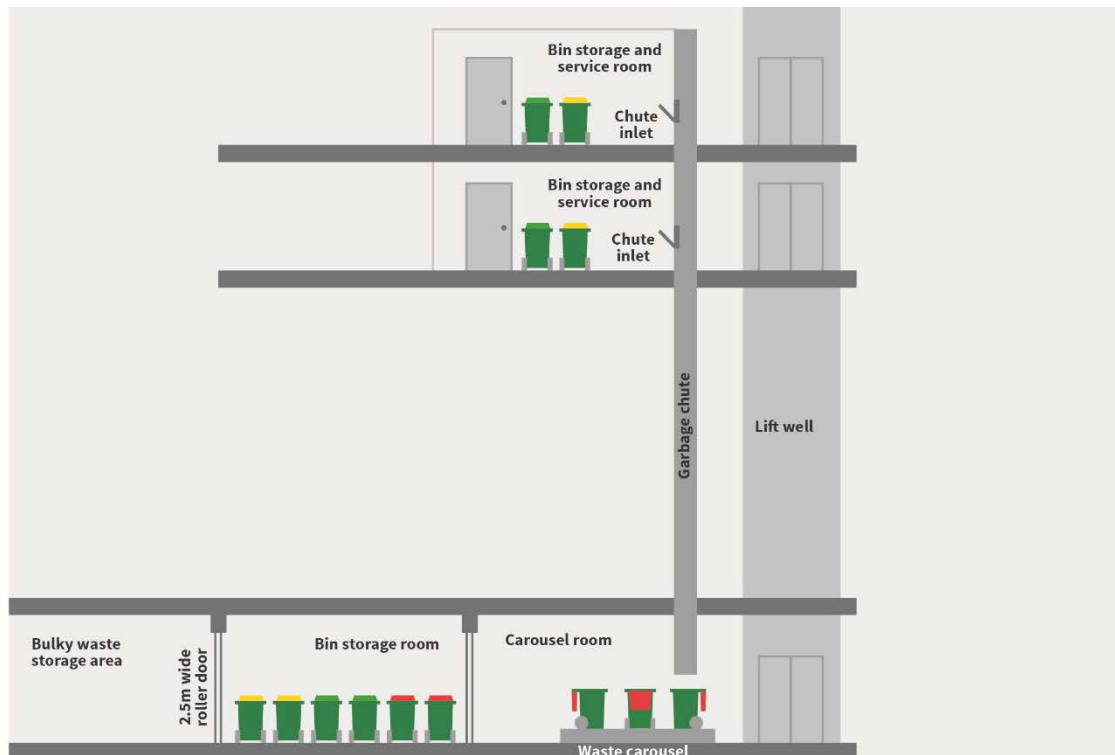

Figure G2.2 illustrates the general principles and operation of a waste chute system supported by recycling and organics bins located in the bin storage and service room on each level. Extra recycling and organics bin storage and the bulky waste storage area are provided in the basement.

In this example, the chute discharges into mobile bins on an automatic carousel, located in a locked room in the basement to which residents do not have access. A bin storage room containing spare recycling and organics bins, and extra waste bins needed to rotate full bins is provided next to the carousel room to maximise convenience and reduce manual handling for the caretaker.

### Design considerations

Waste is deposited into the chute inlet door located on each floor of the building and drops into a bin at the base of the chute. A bin storage and service room is provided on each residential floor (including ground) to allow residents to access the chute inlet and to access recycling and organics bins.

Design considerations for bin storage rooms with chute inlets are as follows:

- Chutes must not open onto any habitable or public space and doors must have an effective self-sealing system.
- The chute discharge outlet must have restricted access to prevent damage to equipment or injuries from people tampering with it.
- Chutes must be completely enclosed in a fire-rated shaft constructed of an approved material and fitted with sprinklers and must comply with the BCA.
- Chute inlets must be accessible to anyone with a disability and comply with *AS1428 Design for access and mobility*.
- Clear signage is required on how to use the system and which materials are acceptable in the chutes and per bin.
- During council collection periods empty bins must be placed at the base of the chute to allow residents to have access to the system at all times.
- Bins at the bottom of the chute can be mounted on an automatic carousel or liner system for easy rotation or can be manually rotated when full. Automatic systems can be fitted with ceiling-mounted compactors or waste can be fed directly into a compacting bin from the chute or decanted into a

waste compactor. Compacting waste helps reduce the number of bins required and saves on space in the bin storage room.

Figure G2.3: Carousel at the bottom of waste chute

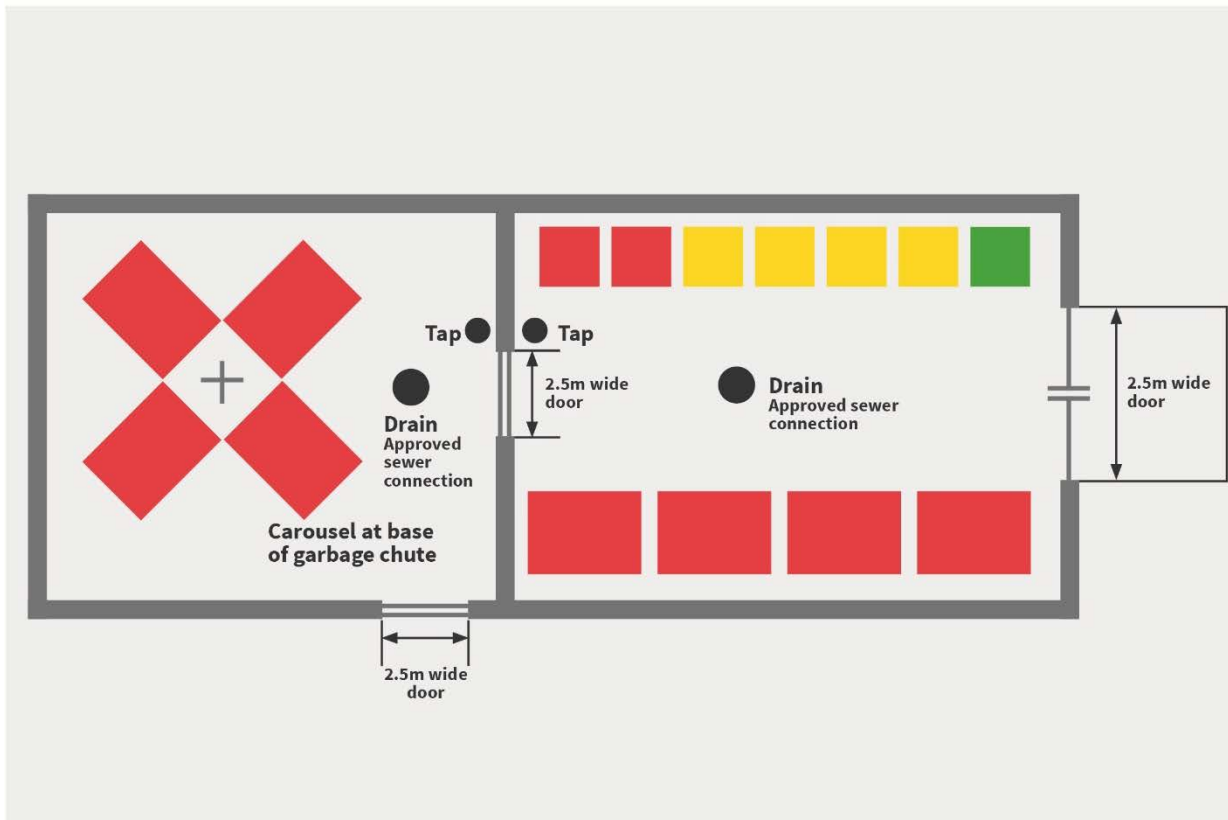

Figure G2.3 illustrates an example of a carousel at the base of the chute system. The carousel is located adjacent to the bin storage area, so the waste bins can be conveniently rotated by a caretaker.

### Dual chute for waste and recycling

A dual-chute system consists of two separate chutes, one for waste and one for recycling. The benefits of dual chutes include:

- simple and easy to use for sorting and collecting waste and recycling
- encourages recycling participation through co-location of waste and recycling chutes
- saves time for residents as they can recycle with ease
- enables waste and recycling from each floor to be disposed of without the need for residents to carry bags and bins in lifts or up and down stairs
- eliminates the need for separate recycling bins on each floor and the time required for cleaners to swap full bins for empty ones.

The disadvantages of dual chutes include:

- potential contamination of recycling bins if residents place general waste in recycling chutes
- potential poor resource recovery if residents place recycling in the waste chute
- requires a full-time caretaker for regular maintenance and clearing of any blockages in the chutes
- requires installation of two chute shafts
- does not provide a solution for food waste.





Example of a dual waste and recycling chute inlet in a bin cupboard in a low-rise residential building (Photo: Andrew Quinn)

## Diverter chutes

Diverter chute systems consist of a single chute for both waste and recycling. The resident selects either waste or recycling by pressing a button on the front panel. The material placed in the chute is automatically diverted either to a waste or recycling bin at the base of the chute.

Diverter chute systems are not recommended for developments of more than 10 storeys. This is because as the system is being used it locks while the material is deposited. This prevents residents on other floors from using the chute for a short period of time. In developments with many floors, the waiting time can become excessive when many residents try to use the system at the same time.



Example of a diverter chute system (waste and recycling) using 660L bins (Photo: Andrew Quinn)

Figure G2.4: Example of a single-chute with diverter

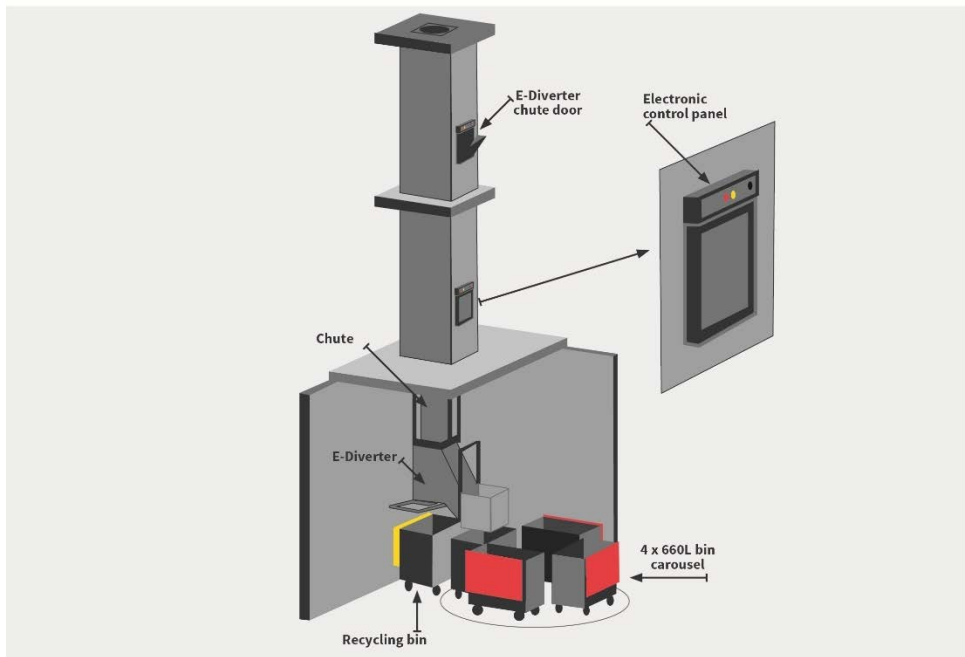

Figure G2.4 demonstrates the operation of a chute system with a diverter for waste and recycling. Residents select the material type (waste or recycling) and place the material in the chute inlet. The switching device moves the chute to the correct bin and the material is deposited into bulk bins. The bins are placed on an automatic carousel and rotated when full.

## Automatic carousel bin systems

There are two types of automatic bin rotation systems for use under a chute: linear and carousel. These systems have a sensor plate located under the chute which is activated when the bin is full.

Linear systems feature two rails between which bins are positioned. The bins slide automatically along the rails so that one bin is always under the chute. Linear systems are available for 240, 660 and 1100L bins and accommodate a minimum of two bins. A compactor can be fitted to a linear system.

Carousel systems feature a circular stand to which bins are attached. One bin is always under the chute while another is under the ceiling-mounted compactor. The carousel automatically rotates to position empty bins under the chute as required. Carousel systems are available for 240, 660 and 1100L bins and accommodate between two and six bins.

## Waste compactors

Approval must be sought from the local council before committing to any system using chutes and compactors.

Waste compactors are used to compress waste to reduce its overall size and increase density. This also helps to reduce the number of bins required and the overall footprint of the bin storage area. Many types of waste compactors are available, and they vary in size. There are two types of compactor systems used in RFBs:

1. systems that require waste to be transported away from where it is collected under a chute and decanted into a compacting unit
2. systems that compact directly into a bin sitting under the chute outlet (such as a ceiling mounted compactor). Compacting directly into bins eliminates the need to manually load waste into a compactor.

Compaction ratios into mobile bins are typically set at around 2:1. The use of higher compaction ratios is not recommended as this can damage bins, increase WHS risks and cause compacted waste to jam in the bins.

Compactors require regular maintenance and should only be installed in buildings that have a building manager, caretaker or cleaners onsite. The room containing the compactor must have restricted access to help prevent damage to the machine and injuries to residents.

Compactors should not be used for compacting mixed recycling containing glass. During compaction the glass may break resulting in glass fines that contaminate paper and cardboard. Specially designed balers and glass bottle crusher systems are more effective for compacting separated paper and cardboard or separated glass.

Some councils do not support compaction of waste due to the damage they can cause to plastic mobile and bulk bins. Early consultation with the council's waste management section is recommended when considering installing compacting equipment.



A bulk 660L bin on an automatic bin carousel with ceiling-mounted compaction (Photo: Andrew Quinn)

### Static (stationary) compactor units

Typical static compactors have two parts: the compactor itself (a hydraulic ram that compresses waste material) and a bin (into which the waste is forced, and which can have different capacities). A stationary compactor has the compactor ram unit permanently fixed to the ground. Only the bin is detached for emptying. They are typically used where a large capacity is required, the waste being collected does not have a high moisture content and there is enough space to fit the compaction unit fixed to the ground.



Two x 3 m3 bulk bins attached to a small-scale static compactor at the base of a chute (Photo: Andrew Quinn)

### Transportable compactor units

Also known as an 'integrated' compactor, these units work the same way as static (stationary) compactors but the ram section and the bin are joined in one complete unit. This means that, when the compactor is collected for emptying, the whole unit is removed. They are typically used where the waste being collected has a high moisture content, such as from fresh food retailers and supermarkets.

### High-capacity systems

In large developments of more than 400 apartments, larger capacity static compactors may be considered with council approval. Generally known as 'hook-lift' compactors, these systems come in a range of sizes with up to 40m<sup>3</sup> capacity which, when combined with a 3:1 compaction ratio, can hold up to 90m<sup>3</sup> of waste. This means that the frequency of collection can be significantly reduced, depending on the quantities. They are more suitable for commercial or larger residential developments.

Hook-lift compactors require waste collection vehicles to reverse directly onto them, so the building will require enough turning and manoeuvring space for heavy rigid class collection vehicles. Access for these kinds of vehicles should be modelled using turning circle software during the design stage.

Hook-lift compactors are normally provided by a waste contractor as part of a service package and come in two types: static and transportable.



Example of a hook-lift compaction container

## Appendix H: Vehicle access and turning circles

### General

Appropriate heavy rigid vehicle standards should be incorporated into the road and street designs in new developments where onsite collections are proposed. Road and street designs must comply with relevant Acts, regulations, guidelines, and codes administered by Austroads, Standards Australia, NSW Roads and Maritime Services, WorkSafe NSW and any local council traffic requirements.

Applicants and building designers should consult with councils and other relevant authorities before designing new roads or streets and access points for waste collection vehicles to establish specific design requirements.

### Road and driveway construction and geometry

Roads, streets and driveways must be designed to allow the safe passage of laden collection vehicles in all seasons. It is recommended that thoroughfares allow for the operation of heavy rigid class vehicles. This should ensure it will still be possible to access these areas even if the configuration of waste collection fleets change in the future.

Factors to be considered in design include:

- gradients for turning heads
- longitudinal road gradients
- horizontal alignments
- vertical curves
- cross-falls
- carriageway width
- verges
- pavement widths
- turning areas
- local area traffic management requirements
- sight distance requirements
- clearance heights
- manoeuvring clearances
- road strength.

### Collection from basements

Collection vehicles may enter building basements to collect waste and/or recyclables, provided the following requirements are met:

- compliance with AS2890.2 Parking facilities: off-street commercial vehicle facilities
- the basement ceiling is high enough for the collection vehicle to safely enter and lift bins
- vehicles can enter and leave the site travelling forward with minimal reversing onsite
- the basement floor is an industrial-strength pavement designed for a maximum wheel loading of seven tonnes per axle.

### Vehicle turning circles

Turning circles and clearances to kerbs, existing buildings or other obstructions should be designed to accommodate the largest collection vehicle that could service the property (heavy rigid class in most cases).

Any turning circle considerations must also include allowances for driver steering error (manoeuvring clearance) and overhangs. Better practice design always requires vehicle entry and exit from a development with the vehicle travelling in a forward direction.

Where there is a requirement for collection vehicles to turn at a cul-de-sac head within a development, the design should incorporate either a bowl, T- or Y-shaped arrangement. Vehicles should not be required to make more than a three-point turn. Turning circles should comply with *AS2890.2 Parking facilities: off-street commercial vehicle facilities* which provides specifications for turning path and reverse entry manoeuvres for medium and heavy rigid class vehicles. It is recommended that architects and designers use the heavy rigid class vehicle dimensions when planning access and travel paths for onsite waste collection services.

Table H4.1: Australian Standards for turning circles for medium and heavy rigid class vehicles

Vehicle class	Overall length (m)	Design width (m)	Design turning radius (m)	Swept circle (m)	Clearance (travel) height (m)
Medium rigid vehicle	8.80	2.5	10.0	21.6	4.5
Heavy rigid vehicle	12.5	2.5	12.5	27.8	4.5

## Turntables

Vehicle turning circles can be reduced from those in Table H4.1 by using a mechanical turntable (or similar) equipment (subject to council approval).

Turntables allow safe entry and exit for heavy vehicles in a forward direction where space is limited. Some RFBs have turntables fitted for cars and other small vehicles. A turntable for a waste collection vehicle needs to have an additional minimum 12.5m diameter circular clearance zone.



Example of vehicle turntable (Photo: Jacobs)

## Appendix I: Standard signage

### Waste signs

Signs and educational materials perform several functions including:

- informing residents why it is important to recover resources and protect the environment
- providing clear instructions on how to use the bins and services provided
- alerting people to any dangers or hazards within the bin storage areas.

All waste, recycling and organic bins should be Australian Standard colours and clearly and correctly labelled, such as by a sticker on the lid and/or the body of the bin.

Communal bin storage areas should be clearly signposted with signs outlining how to correctly separate waste into the bins provided. The local council responsible for waste services may be a good source of signs and posters and can advise on what signs are suitable.

Information on who to contact to find out more about the recycling and/or other resource recovery services in the building should also be displayed in communal areas, such as on a noticeboard.

The Planet Ark website also has resources available free of charge for use by businesses and councils. These signs can be found at [businessrecycling.com.au/research/signage.cfm](http://businessrecycling.com.au/research/signage.cfm)

Figure I1.1: Examples of waste wall posters (EPA supplied)



Figure I1.2: Examples of bin lid stickers (EPA supplied)





## Problem waste signs

The EPA has also produced a range of images and signs that can be used for problem wastes, such as fluoro globes and tubes, household and car batteries, e-waste and smoke detectors. To access these resources, contact the NSW EPA. Some examples are shown below.

Figure I2.1: Problem waste signs



## Safety signs

The use of safety signs for waste resource recovery rooms must comply with *AS1319 Safety signs for occupational environments*. Safety signs must be used to regulate and control safety related to behaviour, warn of hazards and provide emergency information, including fire protection information. Suitable signs should be decided for each development as required.

Figure I3.1: Example safety signs

