

DIESEL LOCOMOTIVE Fuel Efficiency & Emissions Testing

Prepared for NSW EPA



ABMARC

© Copyright State of NSW and the Environment Protection Authority

Disclaimer

This report was prepared by ABMARC in good faith exercising all due care and attention, but no representation or warranty, express or implied, is made as to the relevance, accuracy, completeness or fitness for purpose of this document in respect of any particular user's circumstances. Users of this document should satisfy themselves concerning its application to, and where necessary seek expert advice in respect of, their situation. The views expressed within are not necessarily the views of the Environment Protection Authority (EPA) and may not represent EPA policy.



Diesel Locomotive Fuel Efficiency & Emissions Testing

REPORT

For the NSW EPA

November 2016

ABMARC

www.abmarc.com.au

Phone: +61 3 9729 5129

Email: info@abmarc.com.au

Address: 7/51 Kalman Drive
Boronia, VIC, 3155

CONTENTS

Executive Summary.....	5
List of Tables, Charts and Figures.....	9
Acronyms.....	10
Glossary of Terms.....	11
Abbreviations.....	12

TEST OVERVIEW

Project Overview.....	14
Test Program Overview.....	15
Locomotive Overview.....	17
Test Procedures & Site Location.....	19
Instrumentation.....	23

RESULTS

Test Results.....	29
Ambient Test Conditions.....	29
Comparison to Tier 0+ Regulations.....	30
Cycle Weighted Results.....	31
Fuel Consumption.....	32
Emissions.....	33
Operating Temperatures.....	38

APPENDICES

A Summary Results.....	42
B Correction Factors.....	43
C Variations to CFR 40 1065.....	44
D BSFC Corrections.....	45
E PEMS Overview.....	46

EXECUTIVE SUMMARY

PROJECT OVERVIEW:

The aim of this project was to establish the baseline exhaust emissions and fuel consumption of General Electric powered NR121 and 9317 locomotives owned and operated by Pacific National. The project was commissioned by the NSW Environment Protection Authority (EPA). The locomotive testing was conducted in general accordance with USA CFR 1065, 1033 and 92, and occurred in July 2016 in the UGL facility in Broadmeadow, NSW.

PROJECT BACKGROUND:

Non-road diesel emissions, including those from locomotives, are unregulated in Australia. In response to environmental and health concerns, the NSW EPA developed a "Diesel and Marine Emissions Management Strategy" that sets out actions to progressively control and reduce emissions from priority non-road diesel and marine sources, including locomotives.

The EPA is working with the rail industry on best practice measures for reducing exhaust emissions from diesel locomotives. This project was a continuation of the EPA research study into emissions and fuel efficiency of locomotives operating in NSW. The previous project, completed in 2015, which assessed the emission and fuel efficiency impacts of the installation of emission upgrade kits on locomotives powered by Electro-Motive Diesel (EMD) engines, was the first part of the research (<http://www.epa.nsw.gov.au/resources/air/diesel-locomotive-emissions-report.pdf>). The purpose of this follow on project was to assess the fuel efficiency and emission performance of two classes of locomotives powered by General Electric (GE) engines in common use in NSW freight operations, and to compare emission testing results against the US Tier 0+ locomotive emission standards.

Two GE powered locomotives, a NR Class and a 93 Class, were tested in this project. Both locomotives are powered by 7FDL-16 engines that are claimed by GE to meet the US Tier 0+ particulate matter (PM) limit without installation of emission upgrade kits. Pacific National has recently completed a major maintenance and upgrade program for NR Class locomotives (3,170 kW). The locomotive upgrade, conducted by UGL, features the latest electronic fuel injection system used on the more modern 3,355 kW AC traction C44ACi model locomotives (used in 93 Class). The 93 Class locomotive was tested in standard configuration.

NSW EPA collaborated on this project with a locomotive operator, Pacific National. Pacific National funded: the supply of the locomotives for test from their operating fleet and the costs of fuel and technical personnel to support the test program. UGL, Pacific National's maintenance contractor for GE locomotives, supplied the site for the testing, the exhaust stack and connections from the fuel measurement system to the locomotive and labour for the fitment and removal of test equipment in addition to operation of the locomotive during the tests. NSW EPA funded the emissions and fuel efficiency measurements and reporting and ABMARC conducted the test measurements.

MEASUREMENTS:



Emissions

Emissions were measured with a Portable Emissions Measurement System (PEMS), providing repeatability of 1% or better and complying with US EPA and ECE regulations.

- **Particulate Matter (PM):** Collected on gravimetric filter
- **Gaseous:** Total Hydrocarbons (THC), Carbon Monoxide (CO), Carbon Dioxide (CO₂), Nitric Oxide(NO) and Nitrogen Dioxide (NO₂)

The exhaust gas sample was taken from probes in an exhaust stack extension and transferred via temperature controlled sample lines to the gaseous analysers and gravimetric filter.



Fuel Consumption

Fuel consumption was measured from a high precision Coriolis mass flow meter with an accuracy of $\pm 0.1\%$ for liquids.

Fuel properties were determined to correct Brake Specific Fuel Consumption (BSFC) and emissions to standard fuel data.



Power

Electrical power generated was calculated instantaneously from voltage and current measurements across all locomotive generators with a combined accuracy better than 2%.

Total engine shaft power was the sum of the power produced by each alternator with alternator efficiency factors and mechanical loads applied. This calculation was performed by GE and the results provided to ABMARC.

OUTPUT:

In each test mode the following was measured and has been reported:

- Grams [g] of emissions per unit of work [kWhr]
- Grams [g] of fuel burned per unit of work [kWhr]. Also known as *Brake Specific Fuel Consumption (BSFC) [g/kWhr]*

LOCOMOTIVE TEST SEQUENCE

One 93 Class locomotive, 9317 (GE 7FDL-16 engine ~ 3,355 kW) and one NR class locomotive, NR121 (GE 7FDL-16 ~ 3,170 kW) were tested according to the following:

- Baseline emissions and fuel efficiency test: Two tests per locomotive in their present standard configuration (NR121 after completed upgrade).

EMISSIONS TEST PROCEDURE:

The test cycle was conducted in general accordance with US EPA Title 40 CFR Part 1065, 1033.515, and Part 92 utilised for fuel flow calculations due to the selected measurement method.

An illustration of the test procedure followed is shown in Figure 1.

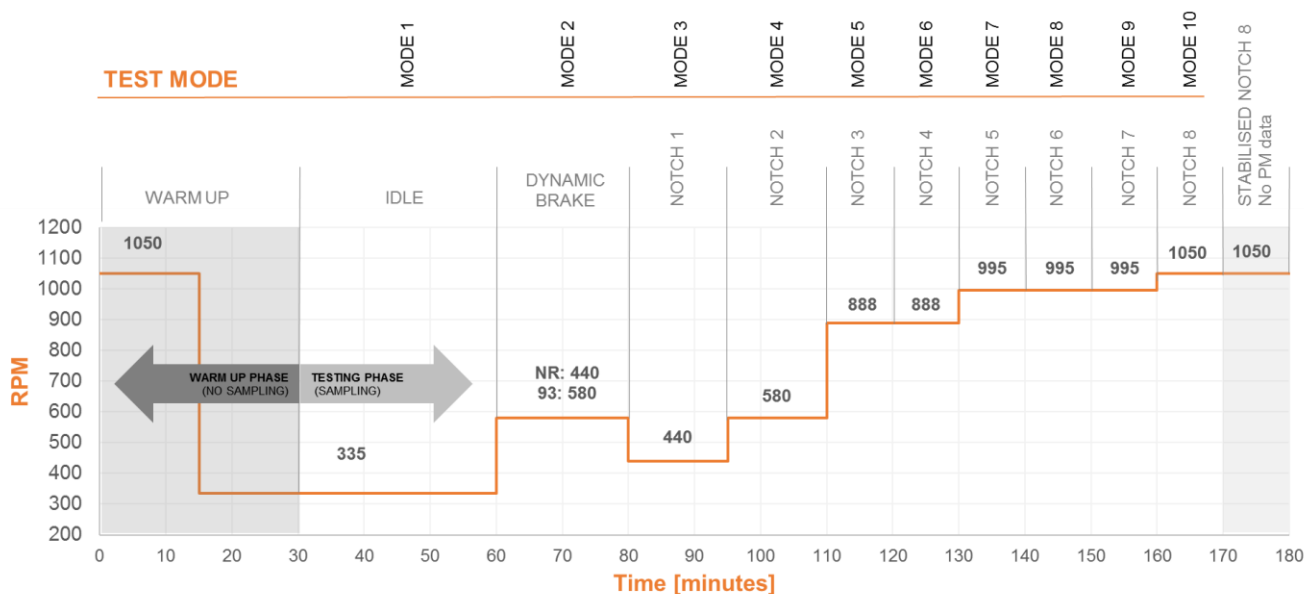

Figure 1 - Test Cycle

EMISSIONS RESULTS:

Cycle Weighted Results for NR121

The test to test repeatability achieved on locomotive NR121 was excellent, as seen in Figure 2 below, with the Test 2 emission results generally slightly lower than Test 1. The cycle weighted BSFC results were almost identical between Test 1 and Test 2, whilst PM was lower by 4.5%, NO_x by 0.5%, CO by 5.3%, and THC lower by 1% in Test 2.

	BSFC	PM	NO _x	CO ₂	CO	THC
Baseline Test 1	210	0.101	16.6	649	1.117	0.519
Baseline Test 2	209	0.096	16.5	648	1.057	0.513
% Difference	-0.0%	-4.5%	-0.5%	-0.2%	-5.3%	-1.0%
	BSFC (g/kWhr)	PM (g/kWhr)	NO _x (g/kWhr)	CO ₂ (g/kWhr)	CO (g/kWhr)	THC (g/kWhr)
NR121	BSFC	Exhaust Emissions				

Figure 2 – Cycle Weighted Results for NR121

Cycle Weighted Results for 9317

The test to test repeatability achieved on locomotive 9317 was also very good, as demonstrated in Figure 2 below. The cycle weighted BSFC result was slightly higher in the second test by 0.7%, while PM was lower by 2.9%, NO_x lower by 1.2%, CO lower by 0.6%, THC was lower by 1.2% in Test 2. CO₂ was higher by 0.5% in Test 2.

	BSFC	PM	NO _x	CO ₂	CO	THC
Baseline Test 1	213	0.107	12.2	662	1.194	0.464
Baseline Test 2	215	0.104	12.0	665	1.188	0.458
% Difference	0.7%	-2.9%	-1.2%	0.5%	-0.6%	-1.2%
	BSFC (g/kWhr)	PM (g/kWhr)	NO _x (g/kWhr)	CO ₂ (g/kWhr)	CO (g/kWhr)	THC (g/kWhr)
9317	BSFC	Exhaust Emissions				

Figure 3 – Cycle Weighted Results for 9317

Particulate Matter & NO_x Compared to Tier 0+ Standard

The average test results for PM and NO_x for each locomotive are compared to the Tier 0+ limits in Chart 1. As shown in Chart 1 below it can be seen that NO_x emissions on both locomotives were above the Tier 0+ limit, whilst both locomotives achieved PM levels below the Tier 3 standard.

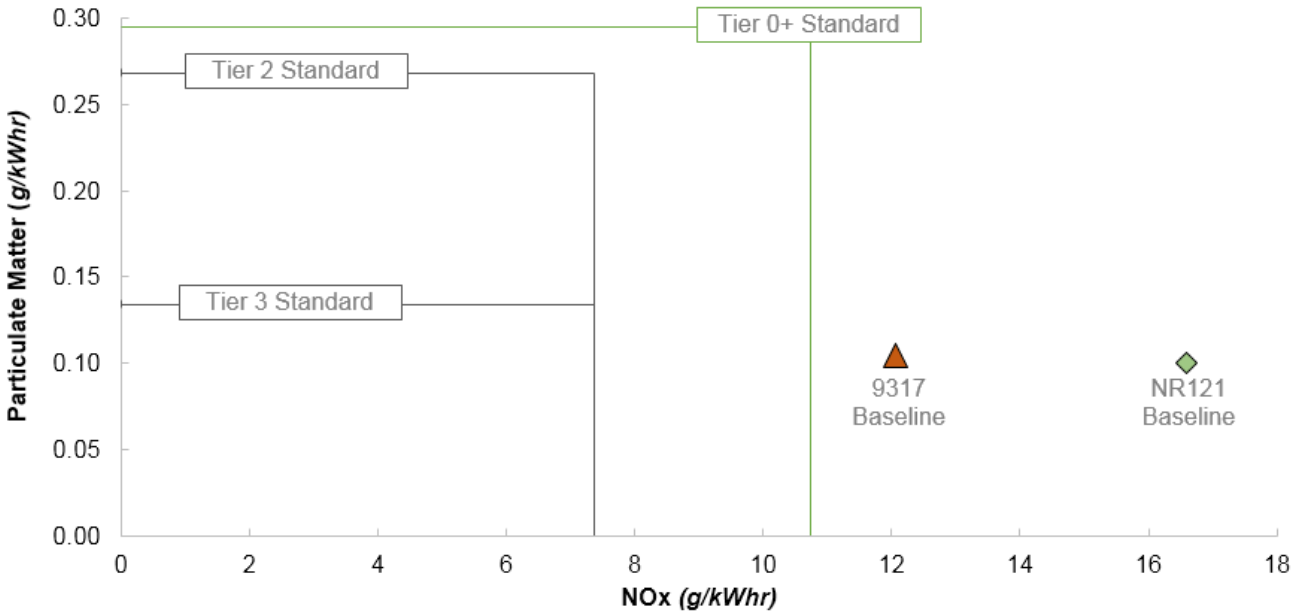

Chart 1 – Emissions Results and US EPA Tier 0+ Standard

CONCLUSION:

This project found that both tested locomotives (NR121 and 9317) achieved emission results below the Tier 0+ requirements for particulate matter (PM), THC, and CO, as presented in Table 1. NO_x emissions, however, exceeded the Tier 0+ standard by 55% on NR121 locomotive and 13% on 9317 and can be seen in Table 2 below.

Emission	Tier 0+ Limits (g/kWh)	NR121 (g/kWh)	9317 (g/kWh)
PM	0.295	0.10	0.11
NO _x	10.7	16.6	12.1
THC	1.34	0.52	0.46
CO	6.71	1.09	1.18

Table 1 – Emission Results compared against Tier 0+ Limits

Emission	% Difference to Tier 0+	
	NR121	9317
PM	-66%	-63%
NO _x	55%	13%
THC	-61%	-66%
CO	-84%	-82%

Table 2 – Emissions Percentage Difference to Tier 0+

LIST OF TABLES, CHARTS & FIGURES

List of Tables

Table 1 – Emission Results compared against Tier 0+ Limits	8
Table 2 – Emissions Percentage Difference to Tier 0+	8
Table 3 – US EPA Line Haul Locomotive Emissions Limits by Applicable Model Year of Manufacture.....	14
Table 4 – NR121: Locomotive Rebuild & Significant Parts Installation History.....	17
Table 5 – 9317: Locomotive Rebuild & Significant Parts Installation History	18
Table 6 - Cycle Weighting Factors for Line Haul Locomotives.....	20
Table 7 – Accuracy and Repeatability of Emissions and Fuel Consumption Instrumentation	23
Table 8 – Emissions Results Compared to Tier 0+ Limits.....	30
Table 9 - Summary of Results	42
Table 10 – Post Processing Fuel Properties	43
Table 11 – Fuel Test Results.....	43
Table 12 – Variations to 40 CFR Part 1065.....	44

List of Figures

Figure 1 - Test Cycle	6
Figure 2 – Cycle Weighted Results for NR121	7
Figure 3 – Cycle Weighted Results for 9317	7
Figure 4 – Project Partners and Contractors	15
Figure 5 – Project Timing.....	16
Figure 6 – Fuel and Emissions Test Standards.....	21
Figure 7 – Emissions & Fuel Consumption Test Site	22
Figure 8 – Emissions and Fuel Consumption Instrumentation.....	23
Figure 9 – Exhaust Stack and Emissions Sample Probes	25
Figure 10 – Power Measurement Instrumentation	26
Figure 11 – Environmental Test Conditions	29
Figure 12 – NR121 Cycle Weighted Test Results	31
Figure 13 – 9317 Cycle Weighted Test Results	31

List of Charts

Chart 1 – Emissions Results and US EPA Tier 0+ Standard	8
Chart 2 – US EPA Line Haul Locomotive Emissions Limits	14
Chart 3 - Locomotive Test Sequence	19
Chart 4 – Emissions Test Results Compared to Tier 0+ NO _x and PM Limits	30
Chart 5 – NR121: Brake Specific Fuel Consumption Results	32
Chart 6 – 9317: Brake Specific Fuel Consumption Results	32
Chart 7 – NR121: PM Emission Results.....	33
Chart 8 – 9317: PM Emission Results	33
Chart 9 – NR121: NO _x Emissions Results	34
Chart 10 – 9317: NO _x Emissions Results	34
Chart 11 – NR121: CO ₂ Emissions Results.....	35
Chart 12 – 9317: CO ₂ Emissions Results.....	35
Chart 13 – NR121: CO Emissions Results	36
Chart 14 – 9317: CO Emissions Results	36
Chart 15 – NR121: THC Emissions Results.....	37
Chart 16 – 9317: THC Emissions Results	37
Chart 17 – NR121: Exhaust Temperature	38
Chart 18 – 9317: Exhaust Temperature	38
Chart 19 – NR121: Charge Air Temperature	39
Chart 20 – 9317: Charge Air Temperature	39
Chart 21 – NR121: Engine Oil Temperature	40
Chart 22 – 9317: Engine Oil Temperature.....	40

ACRONYMS

9317	Locomotive 9317 – 93 Class
NR121	Locomotive NR121 – NR Class
AAR	Association of American Railroads
AC	Alternating Current
AS	Australian Standards
ASTM	American Society for Testing and Materials
AUX	Auxiliary
Avg	Average
BSFC	Brake Specific Fuel Consumption
CFR	Code of Federal Regulations (United States of America)
CO	Carbon Monoxide
CO ₂	Carbon Dioxide
CSIRO	Commonwealth Scientific and Industrial Research Organisation
DC	Direct Current
GE	General Electric
US EPA	United States Environmental Protection Agency (United States of America)
NSW EPA	New South Wales Environment Protection Authority
EU	European Union
FID	Flame Ionization Detector
GFM	Gravimetric Filter Module
HEPA	High Efficiency Particulate Air
N/A	Not Applicable
NATA	National Association of Testing Authorities, Australia
NDIR	Non-Dispersive Infrared
NDUV	Non-Dispersive Ultra-Violet
NO	Nitric Oxide
NO _x	Oxides of Nitrogen
NO ₂	Nitrogen Dioxide
NSW	New South Wales
OEM	Original Equipment Manufacturer
PEMS	Portable Emissions Measurement System
PM	Particulate Matter
PPM	Parts Per Million
RPM	Revolutions Per Minute
Temp.	Temperature
THC	Total Hydrocarbons
US	United States of America
UTEX	Unit Exchange
UV	Ultra Violet
WHO	World Health Organisation

GLOSSARY OF TERMS

Baseline Test: Used to establish reference value(s).

Charge Air: Intake air. Charge air temperature measured just prior to entry to cylinders.

Dilution Air: Conditioned and filtered air used to dilute the exhaust sample entering the particulate matter emissions measurement device.

Particulate Matter Dilution Ratio: Ratio of dilution air to exhaust gas sample that is used for particulate matter measurement.

Drift: Drift is the slow change in the response of a measurement instrument over time.

Dynamic Brake: A mode of operation of the propulsion system in which braking is provided through the use of traction motors as generators, converting the kinetic energy of the locomotive into electrical energy and dissipating this as heat.

Gaseous Emissions: Engine emissions in gaseous form. Includes oxides of nitrogen, carbon monoxide, carbon dioxide and total hydrocarbons.

Notch: Locomotive throttle control position.

Particulate Emissions: Also referred to as Particulate Matter (PM). A complex mixture of small solid and liquid particles suspended in the exhaust gas, often visible as soot and smoke being ejected from the exhaust. In emission standards for internal combustion engines, PM is defined as the material collected on a filter when the exhaust gas is diluted to a temperature of not more than 52°C and passed through a filter.

Remanufacture: Remanufacture in the context of US locomotive emissions standards refers to a scheduled major engine overhaul.

Skip Fire Mode: A version of cylinder deactivation employed on 9317 to improve fuel economy by alternating the cylinders that are fired when the engine operating at a low load or fuel consumption condition.

Span Gas: A gas of known composition used to calibrate the emissions testing devices.

Tier #: The US EPA emissions standards for oxides of nitrogen, hydrocarbons, carbon monoxide, particulate matter and smoke for newly manufactured and remanufactured locomotives.

ABBREVIATIONS

A	Ampere - Electric Current
°C	Degrees Celsius
g	Gram
g/bhp-hr	Grams Per Brake Horsepower Hour
g/kWhr	Grams Per Kilowatt Hour
J	Joule
J/L	Joules Per Litre
L	Litre
L/min	Litres Per Minute
m	Metre
m ³	Cubic Metre
min	Minute
m/s	Meters Per Second
N	Newton
Nm	Newton Metre
Pa	Pascal
ppm	Parts Per Million
RPM	Revolutions Per Minute
s	Seconds
V	Voltage
W	Watt
Whr	Watt Hours

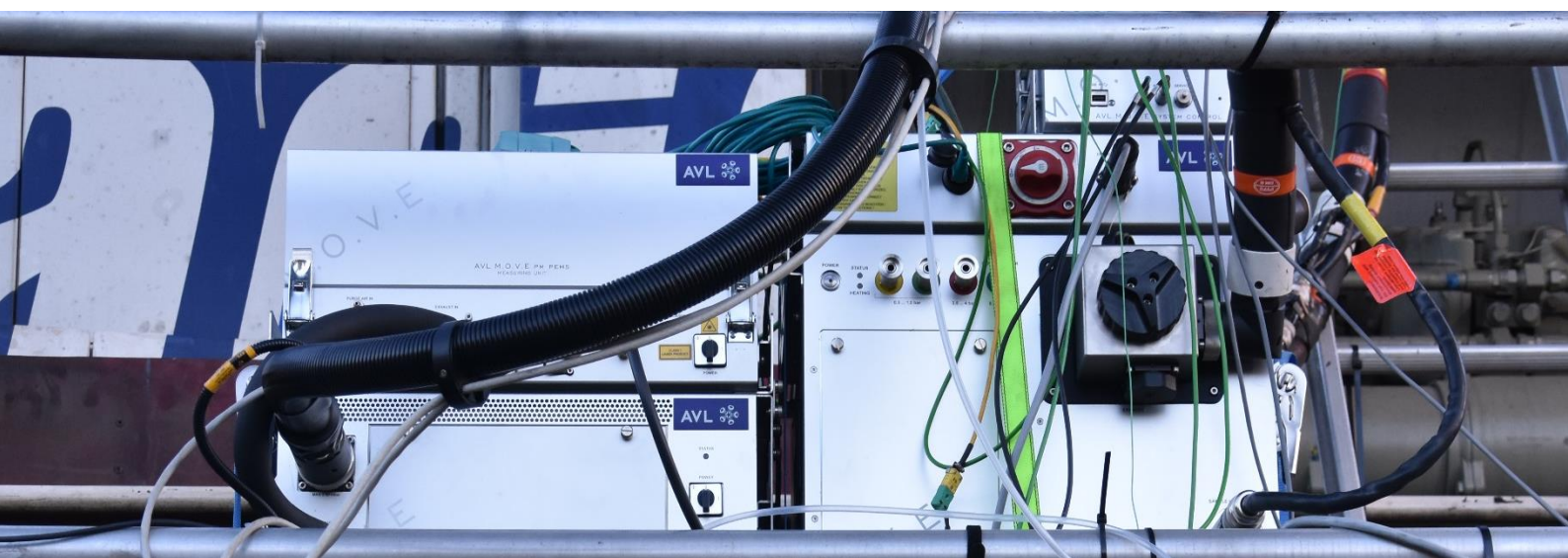

PROJECT OVERVIEW 14

TEST PROGRAM OVERVIEW 15

LOCOMOTIVE OVERVIEW 17

TEST PROCEDURES & SITE LOCATION 19

INSTRUMENTATION 23

PROJECT OVERVIEW

The objective of this testing project was to determine baseline emissions and fuel efficiency of GE powered diesel locomotives operating in NSW. This project followed on from the fuel efficiency and emissions testing study of EMD powered locomotives upgraded with emissions kits (“Diesel Locomotive Emissions Upgrade Kit Demonstration Project”) that NSW EPA conducted in collaboration with locomotive operator, Pacific National, in 2015. EMD and GE locomotives represent together over 90% of locomotives operating in NSW. The locomotive testing aimed to establish the evidence base for best practice emission reduction measures for diesel locomotives operating in NSW. Reducing emissions from priority non-road diesel and marine sectors, including diesel locomotives, is the goal of the EPA’s broader “Diesel and Marine Emissions Management Strategy.”

The project involved the testing of two GE 7FDL-16 powered locomotives in general accordance with US EPA test methods. Locomotives included the NR Class, originally built in 1996 which recently completed a major maintenance and engine upgrade program, and the 93 Class which is the current locomotive type designed and produced by UGL for standard gauge intermodal and heavy haul operations within Australia. Locomotives were tested in their present standard configuration.

Background

In Australia, the two largest locomotive engine OEMs are General Electric (GE) and Electro-Motive Diesel (EMD).

The objective of the GE Diesel Locomotive Testing Project was to measure the emissions and fuel efficiency of two GE locomotives commonly used in NSW and to compare the emissions against the US Tier 0+ locomotive emission standard.

Fuel consumption and emissions testing were conducted in general accordance with US EPA Title 40 CFR Part 1065, 1033.515, and Part 92 utilised for fuel flow calculations due to the selected measurement method.

This report presents the baseline emissions and fuel consumption results of the locomotives in their standard operating configuration.

US Locomotive Emissions Standards

The US EPA introduced Tier 0 to Tier 2 locomotive emission standards in 2000. Tier 0 was applied retrospectively to in-service locomotives built after 1973 at the next major engine overhaul (remanufacture). These locomotive emissions standards were updated in 2008 to more stringent Tier 0+, Tier 1+ and Tier 2+ standards, accompanied by the introduction of Tier 3 and 4 for new locomotives. Regulations for diesel locomotive emissions were also introduced in the European Union (EU) in 2006.

The US EPA emissions regulations apply to locomotives when they are first manufactured, or at their next major overhaul (re-manufacture). For remanufactured locomotives, this requires that they comply with the applicable Tier 0+, Tier 3 or Tier 4

standard as represented in Table 3, based on the model year.

US EPA regulated Line-Haul locomotive PM and NO_x emission limits are shown in Chart 2. Note that locomotives must also comply with switch locomotive emissions limit where applicable. The more stringent Tier+, Tier 3 and Tier 4 standards apply to locomotives manufactured or remanufactured after 2010.

These standards compelled the development of emissions upgrade kits to enable the reduction of emissions from in-service locomotives when remanufactured, in order to comply with the regulatory limits.

Emission Limit	Model Year	NO _x (g/kWhr)	PM (g/kWhr)
Tier 0	1973 - 2001	13	0.80
Tier 1	2002 - 2004	9.9	0.60
Tier 2	2005 or later	7.4	0.27
Tier 0+	1973 - 1992	11	0.30
Tier 1+	1993 - 2004	9.9	0.30
Tier 2+	2005 - 2011	7.4	0.13
Tier 3	2012 - 2014	7.4	0.13
Tier 4	2015 or later	1.7	0.04

Table 3 – US EPA Line Haul Locomotive Emissions Limits by Applicable Model Year of Manufacture

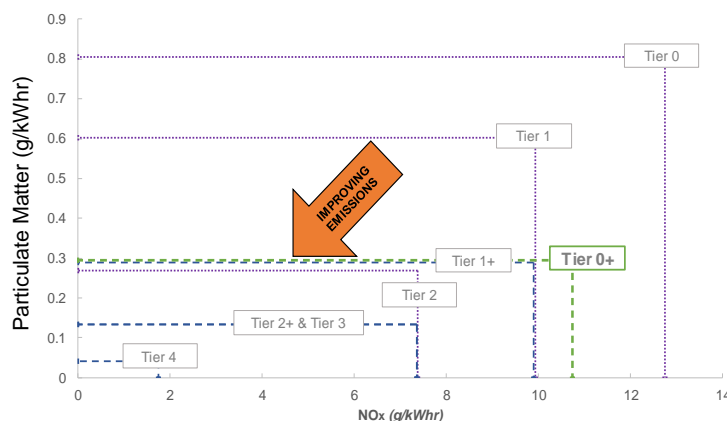

Chart 2 – US EPA Line Haul Locomotive Emissions Limits

TEST PROGRAM OVERVIEW

NSW EPA partnered with Pacific National to carry out the emissions testing project. The testing and reporting was conducted by ABMARC. The testing took place in July 2016 at UGL Rail, Broadmeadow, NSW.

Project Partners and Contractors

NSW EPA collaborated with Pacific National to carry out the GE Locomotive Testing Project. NSW EPA engaged ABMARC to conduct the testing on two Pacific National locomotives to assess their emissions relative to the US EPA Tier 0+ limits and prepare the reports.

Pacific National assisted with funding of the project by making the locomotives available for testing, arranging the fitment and removal of equipment and paying the costs of fuel and technical personnel to support the test program.

UGL maintain the GE locomotives in Pacific National's locomotive fleet. As the designer and manufacturer of both locomotive types, including the recently completed the engine upgrade and locomotive

modernisation program for the NR Class locomotive, UGL provided technical support for the test program. In addition, UGL supplied the site for the testing, the exhaust stack and connections from the fuel measurement system to the locomotive and labour for the fitment and removal of test equipment.

Installation of test equipment was performed by both ABMARC and UGL personnel. The locomotives were operated by a UGL staff member during testing under instruction and observation of ABMARC staff. All testing occurred at the UGL site in Broadmeadow, NSW. Testing was conducted by ABMARC.

An overview of the project participants is shown in Figure 4.

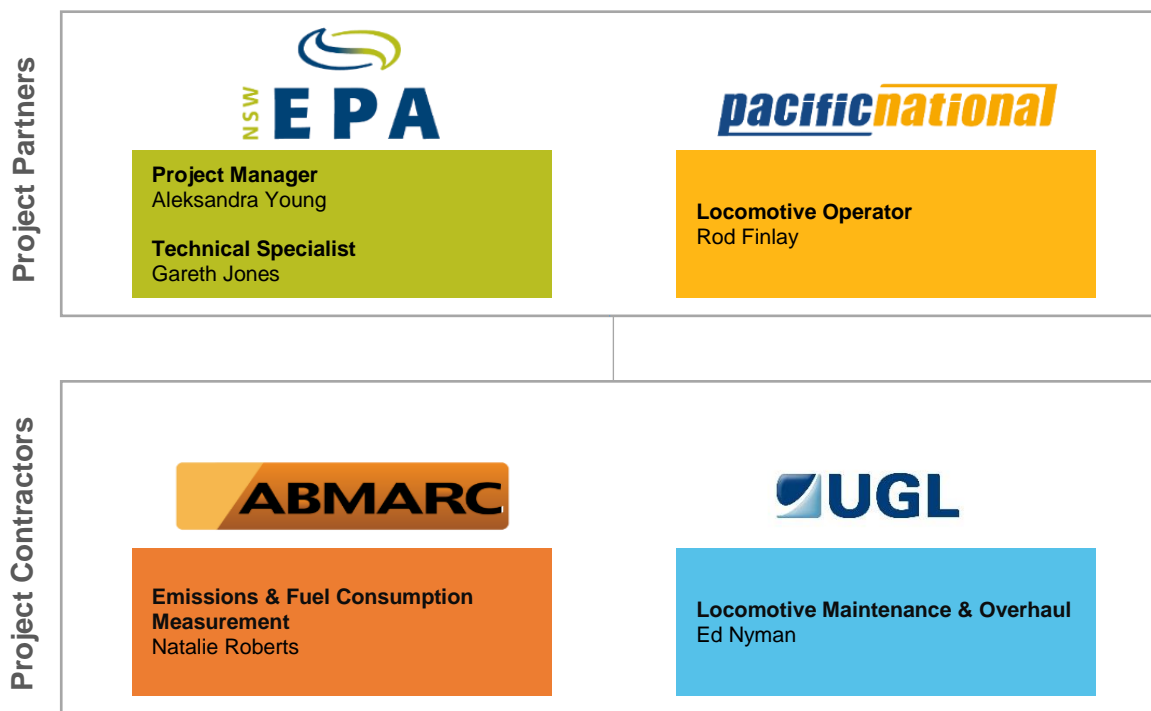

Figure 4 – Project Partners and Contractors

Project Timing

Fuel consumption and emissions testing was conducted from 18th July 2016 to 28th July 2016.

A high-level overview of the project and test timing for both locomotives is shown in Figure 5.

July-2016						
Mon 18	Tue 19	Wed 20	Thu 21	Fri 22	Sat 23	Sun 24
NR121: Equipment Install & Locomotive Preparation		NR121: Locomotive and Test Equipment Validation				
Mon 25	Tue 26	Wed 27	Thu 28	Fri 29	Sat 30	Sun 31
NR121: Baseline Test 1 & 2	Test Equipment Swap	9317: Baseline Test 1 & 2	Locomotive & Test Equipment Decommis- sioning			

Figure 5 – Project Timing

LOCOMOTIVE OVERVIEW

Locomotives NR121 and 9317 were tested in this project. These locomotives were selected to determine their baseline emissions and fuel consumption and to assess the emissions against the US EPA Tier 0+ limits.

Locomotive Specifications and Tested Condition

NR121



Locomotive NR121 was selected as the NR Class test locomotive for emissions and fuel consumption testing on the GE 7FDL-16 engine type. NR121 locomotive was previously NR3 and was rebuilt and renumbered in 1999, after an accident in 1998.

The NR Class was introduced by National Rail in 1996 to be used on national rail services across Australia and is currently operated by Pacific National. The four-stroke 16 cylinder turbocharged GE 7FDL engine that powers NR Class locomotives produces 3,170 kW. The NR Class is used on all Pacific National intermodal and standard-gauge rail services. NR Class locomotives are able to carry 12,500 litre of fuel, which enables them to operate between Melbourne and Brisbane without refuelling.

The NR Class locomotive fleet has recently completed an engine upgrade and modernisation program. The engine upgrade consists of high compression power assemblies (i.e. cylinder/piston combo), changed camshaft profile, multi pass aftercooler and a fuel

injection system upgraded from the original mid '90s Lucas-Bryce system to the latest Bosch configuration of the 93 Class (C44ACi locomotive model). Both fuel injection systems are electronically controlled.

The upgraded engine in the NR Class has essentially the same engine configuration as the C44ACi locomotive used in 93 Class. The significant difference between NR upgrade and the C44ACi is the engine cooling system. The C44ACi locomotive has the 'split-cooled' radiator package enabling higher power output while engines in NR Class are 'non split-cooled'.

Latest Rebuild/Significant Parts History	Date Completed	Operational Kilometres(prior to test 29 July 16)
Upgraded Engine Rebuild with Bosch Electronic Fuel Injection	9 March 2016	64,347

Part	# Hours	Recommended Change Interval
Fuel Injectors*	1,050 MWh at time of testing	13,000 MWh

*The NR Class engine upgrade has been fitted with the latest model Bosch 'Stainless Steel' fuel injectors. Due to their lower wear characteristics the replacement interval has been extended to 13,000 MWhrs.

Table 4 – NR121: Locomotive Rebuild & Significant Parts Installation History



9317

Locomotive 9317 was selected as the 93 Class test locomotive for emissions and fuel consumption testing. This locomotive has been in service since 2014 and is operated by Pacific National.

The C44ACi locomotive used in 93 Class is a model of an Australian heavy duty diesel electric locomotive designed by UGL Rail and built at its Broadmeadow factory. It is operated by a number of rail freight operators. The design is based on the Pacific National NR class but has some modifications and upgraded features. The four-stroke 16 cylinder turbocharged GE 7FDL engine that powers the locomotive produces 3,355kW.

The 93 Class locomotives are used on intermodal freight trains between Melbourne and Brisbane although occasionally they haul The Overland from Melbourne to Adelaide, supplementing the NR's roster. The 93 Class locomotives also operate in the Hunter Valley NSW in coal haulage service.

Latest Rebuild/Significant Parts History	Date Completed	Operational Kilometres (prior to test 29 July 16)
Nil – original build	04/02/2014	378,269

Part	# Hours	Recommended Change Interval
Fuel Injectors	6,742 MWh at time of testing [#]	6,500 MWh

[#] Fuel injectors for 9317 were not replaced prior to the emission test despite being over replacement interval. The overdue life of the injector provided a reference point for emissions levels achieved at the end of the recommended injector service interval rather than as new.

Table 5 – 9317: Locomotive Rebuild & Significant Parts Installation History

TEST PROCEDURES & SITE LOCATION

Emissions and fuel consumption testing and calculations were conducted generally according to US EPA Title 40 CFR Part 1065, 1033.515, and Part 92 utilised for fuel flow calculations due to the selected measurement method. Variations to the standard are outlined in Appendix C. All tests were carried out at UGL Rail's facility in Broadmeadow, NSW.

Locomotive Test Procedure

The test mode duration and procedure were conducted generally according to the US EPA CFR 40 Part 1033.515. The test procedure requires that emissions, power and fuel consumption are measured in each engine operating mode, including idle and dynamic brake. An example locomotive engine RPM and mode duration is shown in Chart 3.

The time in each mode was established based on the CFR and the requirement to load the gravimetric particulate filter with a suitable amount of particulate matter for measurement.

Gaseous emissions, power and fuel flow were sampled continuously for the duration of each test. Gravimetric filters were replaced at the end of each test mode. The gravimetric filters were subsequently weighed at CSIRO's automated weighing facility in North Ryde, NSW.

An additional test was conducted at the end of Mode 10 (notch 8), for the purpose of recording stabilised fuel consumption and gaseous emissions in notch 8, the highest power setting. The stabilised notch 8 data did not include PM measurement.

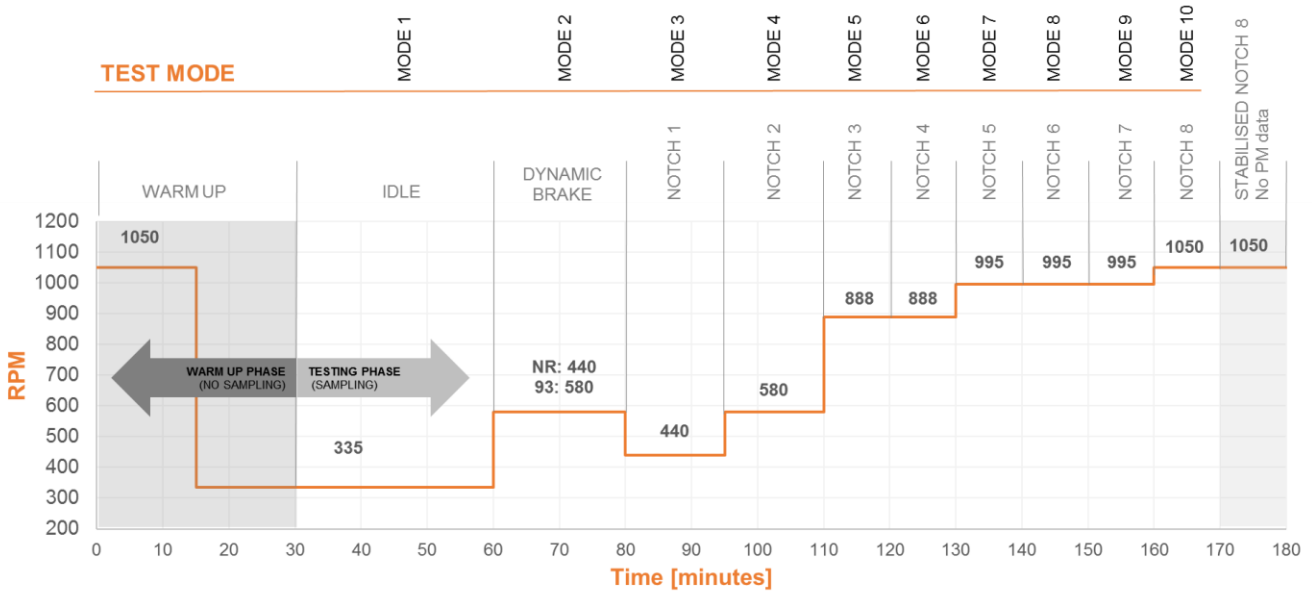

Chart 3 - Locomotive Test Sequence

US EPA Cycle Weighting Factors

To calculate cycle-weighted average emission rates, locomotive operating duty cycles are specified by the US EPA in 40 CFR Part 1033.530. The line haul locomotive weighting factors are shown in Table 6.

The US EPA defines different duty cycles for line haul and switch locomotives in order to represent typical operating conditions based on locomotive type. Line-haul locomotives are defined as locomotives powered by an engine with a maximum rated power (or a combination of engines having a total rated power) greater than 2300 HP or 1716 kW.

NR121 and 9317 are classified as line-haul locomotives.

It is noted that the actual operating cycle of these classes of locomotive can vary substantially to the US EPA averages. This is due to NSW network requirements, freight loading characteristics, and their operational deployment. The operating cycle differences will result in the actual emissions and fuel consumption on these locomotives varying from the US EPA cycle weighted average results presented in this report.

Notch setting	Normal Idle	Dynamic Brake	Notch 1	Notch 2	Notch 3	Notch 4	Notch 5	Notch 6	Notch 7	Notch 8
Test mode	Mode 1	Mode 2	Mode 3	Mode 4	Mode 5	Mode 6	Mode 7	Mode 8	Mode 9	Mode 10
Weighting Factors	0.38	0.125	0.065	0.065	0.052	0.044	0.038	0.039	0.03	0.162

Table 6 - Cycle Weighting Factors for Line Haul Locomotives

Fuel Consumption & Emissions Test Standards

Testing to US EPA CFR 40 Part 1033.515 requires specific procedures to be followed pre-test, during testing, and post-test, and specifies the measurement equipment that can be used.

These requirements relate to:

- Equipment specification and calibration
- Handling of filters (pre and post-test)
- Environmental conditions of the test
- Test methodology
- Calculations

BSFC results have been corrected for temperature and barometric pressure as per the Association of American Railroads (AAR) practice. Refer to Appendix D for fuel calculations.

Fuel flow was calculated as per 40 CFR Part 92.126. The fuel flow value reported for each mode is a one-minute average of the instantaneous fuel flow measurements taken during the last minute of the sampling period as per Part 92.124.

40 CFR Part 1065 has more stringent requirements than 40 CFR Part 92. The Gaseous PEMS meets instrumentation requirements for laboratory testing as specified in 40 CFR Part 1065 subpart C. This is particularly important for testing fuels or technologies to quantify a small improvement in emissions or fuel efficiency.

An overview of the general test standards followed is shown in Figure 6.

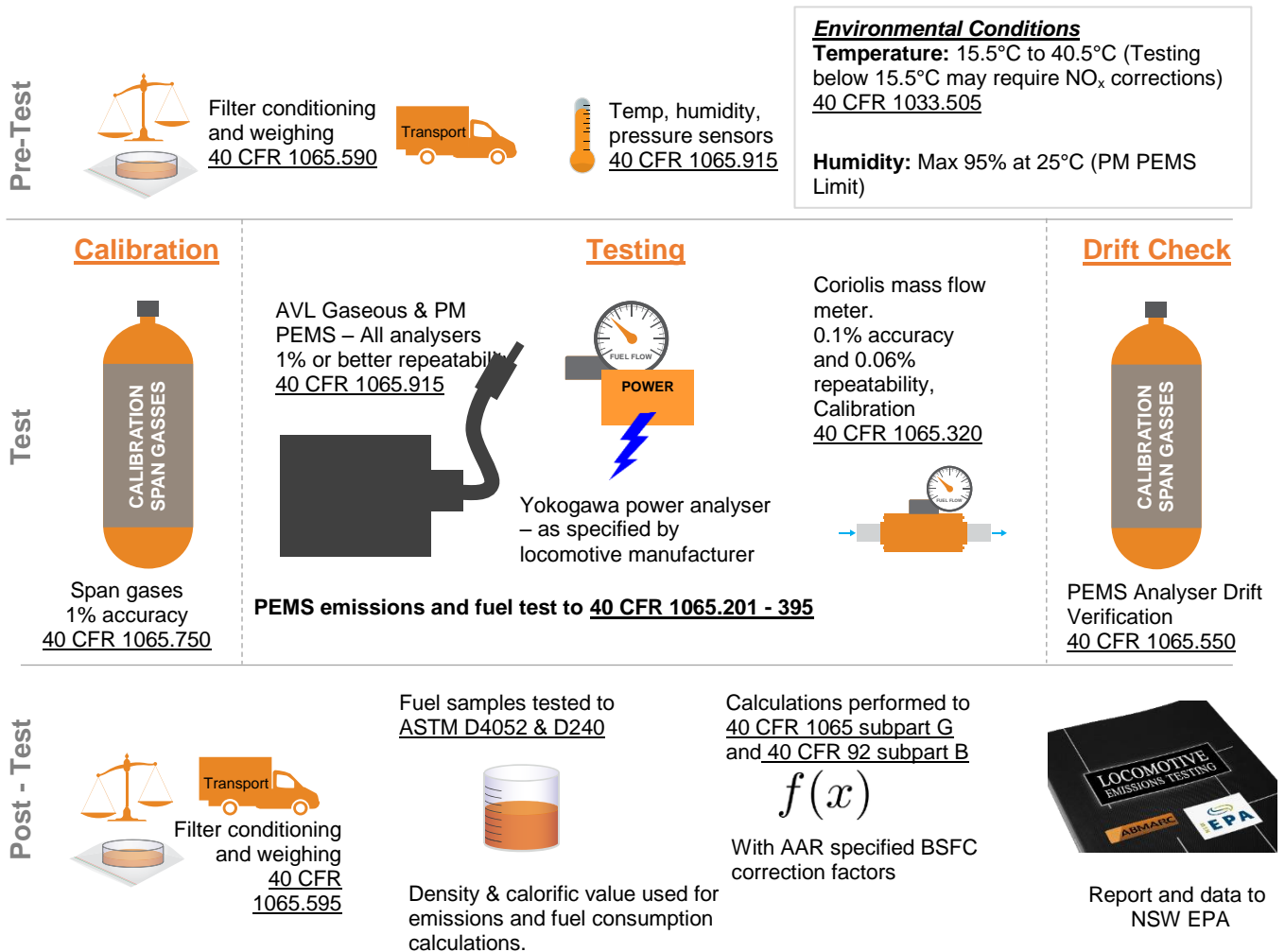

Test Site Location

All testing was conducted at UGL Rail's facility in Broadmeadow, NSW. Emissions and fuel efficiency

testing was conducted in the open air in the location indicated in Figure 7.



Figure 7 – Emissions & Fuel Consumption Test Site

INSTRUMENTATION

Three significant areas were measured, being: emissions, fuel consumption, and power. This section provides an overview of the instrumentation, its installation, and use.

Emissions and Fuel Consumption Measurement Instrumentation

Emissions measurements were performed utilising an AVL Portable Emissions Measurement System (PEMS). The PEMS consists of gaseous analysers for NO, NO₂, CO and THC measurement, contained in an environmentally controlled chamber and a gravimetric filter for PM collection. A continuous sample of exhaust gas was taken from two probes located in the locomotive exhaust stack extension with the sample lines temperature controlled to 191°C (gaseous) and 47°C to 52°C (PM) as required by the CFR. More information regarding the operation of the PEMS can be found in Appendix E.

The ambient conditions (pressure, temperature and humidity) were recorded by the PEMS.

The fuel consumption was measured using a fuel reservoir (“day tank”) and a Coriolis mass flow meter. The supply fuel was pumped from the locomotive

tank via an additional external pump. Fuel flowed into the day tank via the Coriolis mass flow meter to maintain a constant fuel level. Return fuel from the engine was cooled to 30°C with a heat exchanger/chiller unit prior to entering the day tank. Fuel from the drip feed return system was gravity fed to the day tank.

All measurements were performed at 1 Hz or greater.

All test equipment is calibrated in accordance with 40 CFR Part 1065 specifications to the appropriate NIST or equivalent standard. The equipment exceeds many of the CFR requirements for repeatability (refer to Table 7 for more information).

An overview of the instrumentation setup is presented in Figure 8.

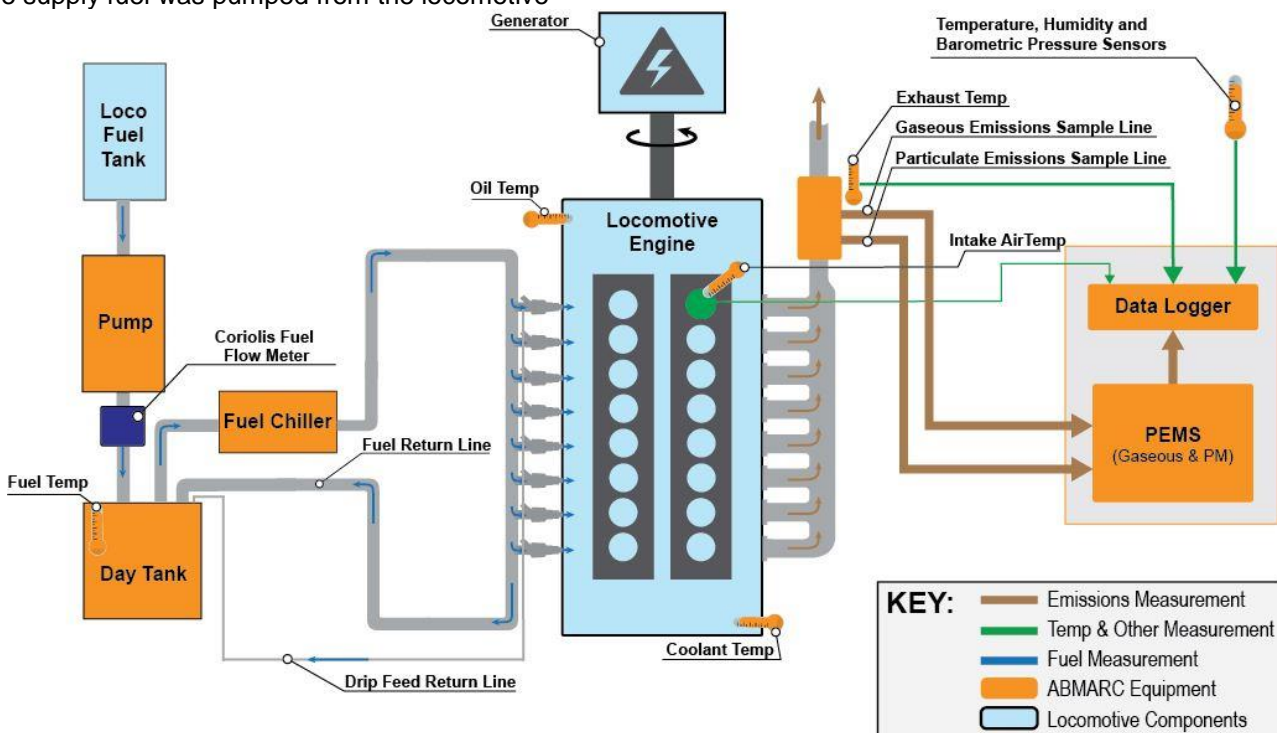

Figure 8 – Emissions and Fuel Consumption Instrumentation

Attribute	CFR 40 Part 1065 requirement		AVL PEMS & Fuel Flowmeter	
	Accuracy	Repeatability	Accuracy	Repeatability
Fuel flow (combined)	± 2% pt	± 1% pt	± 0.1%	± 0.06%
	± 1.5% of max	± 0.75% of max		
CO/CO ₂	± 2%	± 1%	± 2%	± 1%
Hydrocarbons	± 2%	± 1%	± 2%	± 0.5%
NOx (NO ₂ /NO)	± 2%	± 1%	± 2%	± 0.5%
PM (Gravimetric)	See 1065.790 / 2%	0.5 micro grams / 1%	Satisfied	Satisfied

Table 7 – Accuracy and Repeatability of Emissions and Fuel Consumption Instrumentation



PEMS setup with emissions sample lines (example)



Data monitoring of all measurement items (example)

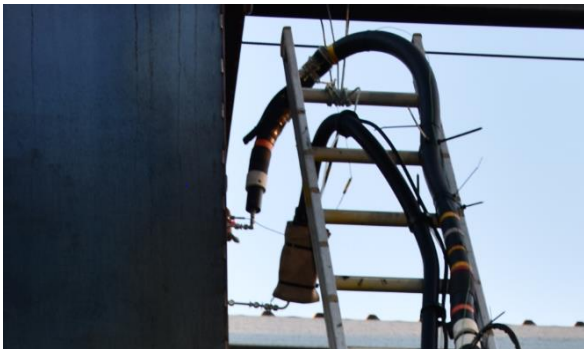

Emissions sample lines & exhaust stack



Power measurement



Fuel chiller

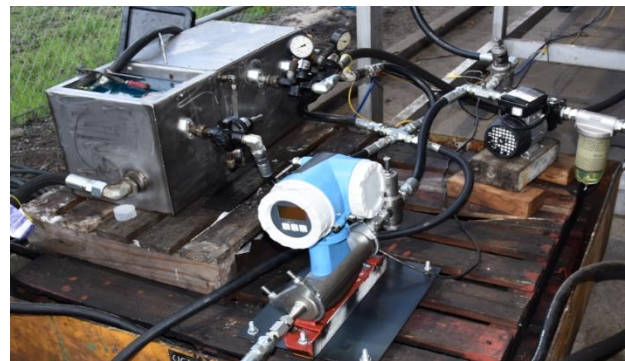

Coriolis fuel flow meter, day tank and pump arrangement

Exhaust Stack and Emissions Sampling

An exhaust stack extension was manufactured for the locomotives. The exhaust stack extension provides a well-mixed exhaust flow to the exhaust sample probes and was designed to prevent dilution of the sample with ambient air. The sample probes were installed according to 40 CFR Part 1065. The probe configuration is shown in Figure 9, with two sample probes installed, one for gaseous and one for PM emissions, located in the centre of the exhaust stream.

The PM probe comprises a 90° bend with a single opening orientated into the exhaust stream. The raw PM sample gas was diluted with filtered and dried ambient air within 250mm of the sample point at a

constant dilution ratio of 5:1. The diluted PM exhaust sample was transferred to the gravimetric filter and soot sensor modules via a transfer line heated to between 47°C and 52°C.

The gaseous probe comprises a closed end probe with a number of inlet holes along its length to draw the sample gas in. The raw exhaust gas was passed to the emissions analysers via a sample line heated to 191°C.

An exhaust gas temperature sensor was located between the PM and gaseous sample probes.

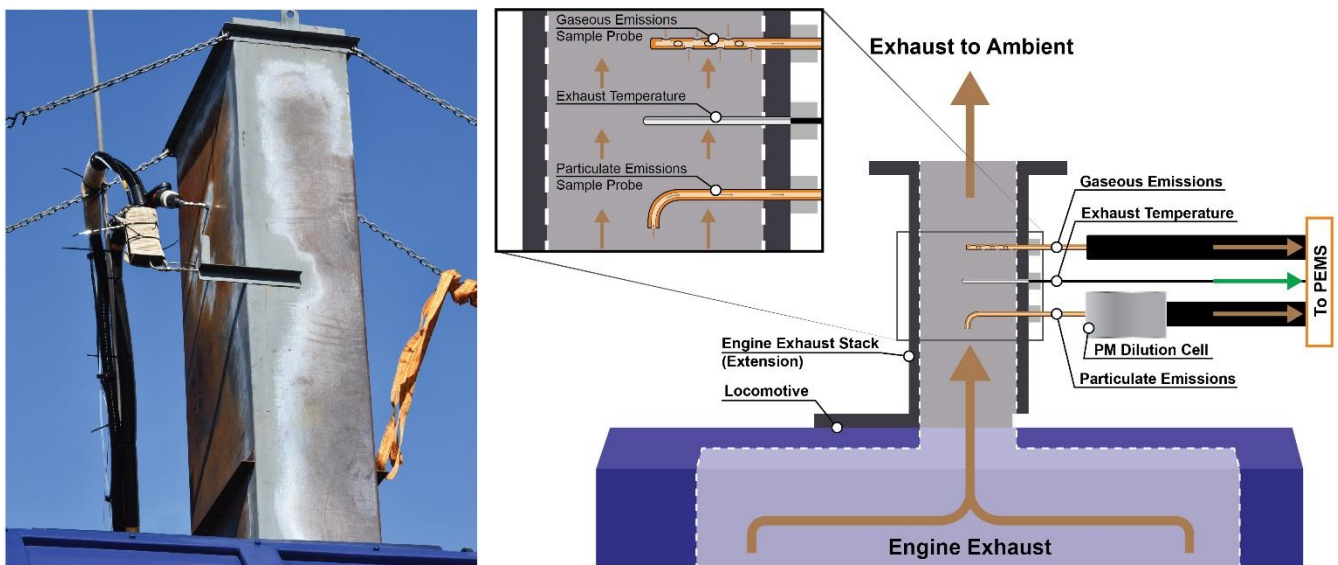
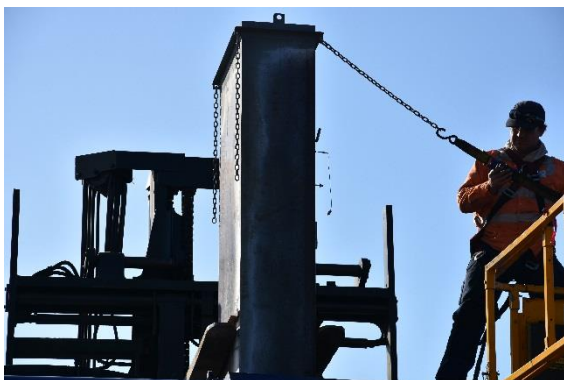
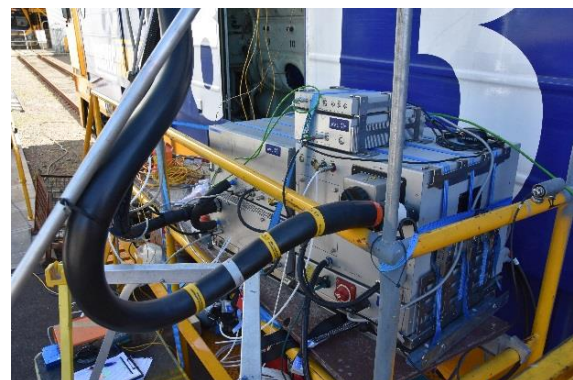

Figure 9 – Exhaust Stack and Emissions Sample Probes



Installing exhaust stack extension



Gaseous heated sample entry to PEMS

Power Measurement Instrumentation

The locomotive engine drives three alternators, the main traction, battery charger, and auxiliary alternator.

Instantaneous measurements of current and voltage across each alternator were taken to determine the electric power produced. High accuracy current clamps or transducers were installed around the power cables from the alternator and the voltage was measured directly, with the exception of the main generator voltage, which was measured via a 0-10V transducer. This setup is shown in Figure 10. Current and voltage signals were input to a laboratory grade power analyser. All test equipment is calibrated in

accordance with 40 CFR Part 1065 to the appropriate NIST or equivalent standard.

Electric power was calculated for all alternators from the voltage and current outputs using the 2-Watt meter method with total combined accuracy better than 2%.

Total engine shaft power was the sum of the power produced by each alternator with alternator efficiency factors and mechanical loads applied. This calculation was performed by GE and the results provided to ABMARC.

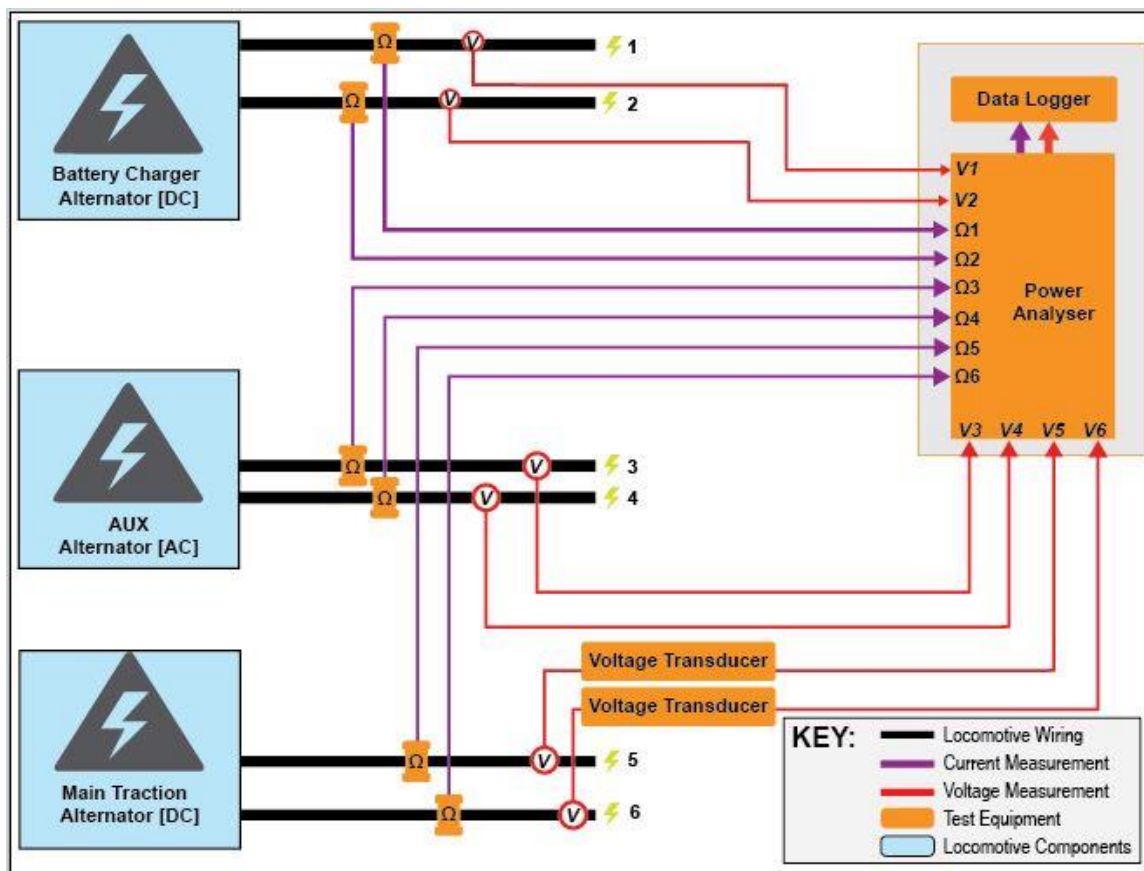
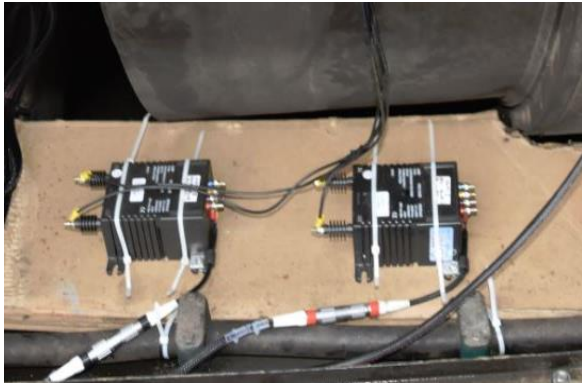

Figure 10 – Power Measurement Instrumentation



Voltage transducer on main alternator



Current clamps for battery & auxiliary alternator



Current transducer on main AC alternator



Power measurement device installed in cabin



RESULTS

TEST RESULTS	29
AMBIENT TEST CONDITIONS	29
COMPARISON TO TIER 0+ REGULATIONS	30
CYCLE WEIGHTED RESULTS	31
FUEL CONSUMPTION	32
EMISSIONS	33
OPERATING TEMPERATURES	38

TEST RESULTS

This section outlines the results from testing locomotives NR121 and 9317.

The environmental conditions of each test were generally in accordance with the relevant specifications of 40 CFR 1033 and Part 92, except for two tests for ambient temperature, which were just below the limit.

Fuel data was not available for the Baseline test 1 mode 2 (dynamic brake) on locomotive 9317 due to a technical issue in this test point only.

Summary results of all baseline tests can be found in tables in Appendix A.

Ambient Test Conditions

Emissions and fuel consumption testing conformed generally to the environmental requirements specified by US EPA 40 CFR 1033 and Part 92. The ambient test temperature was slightly below the requirement of 15.5°C for two of the tests conducted, however engineering judgement is allowed in relation to NO_x

corrections. In this case, no NO_x corrections were made for temperature. The test environmental conditions are outlined below in Figure 11.

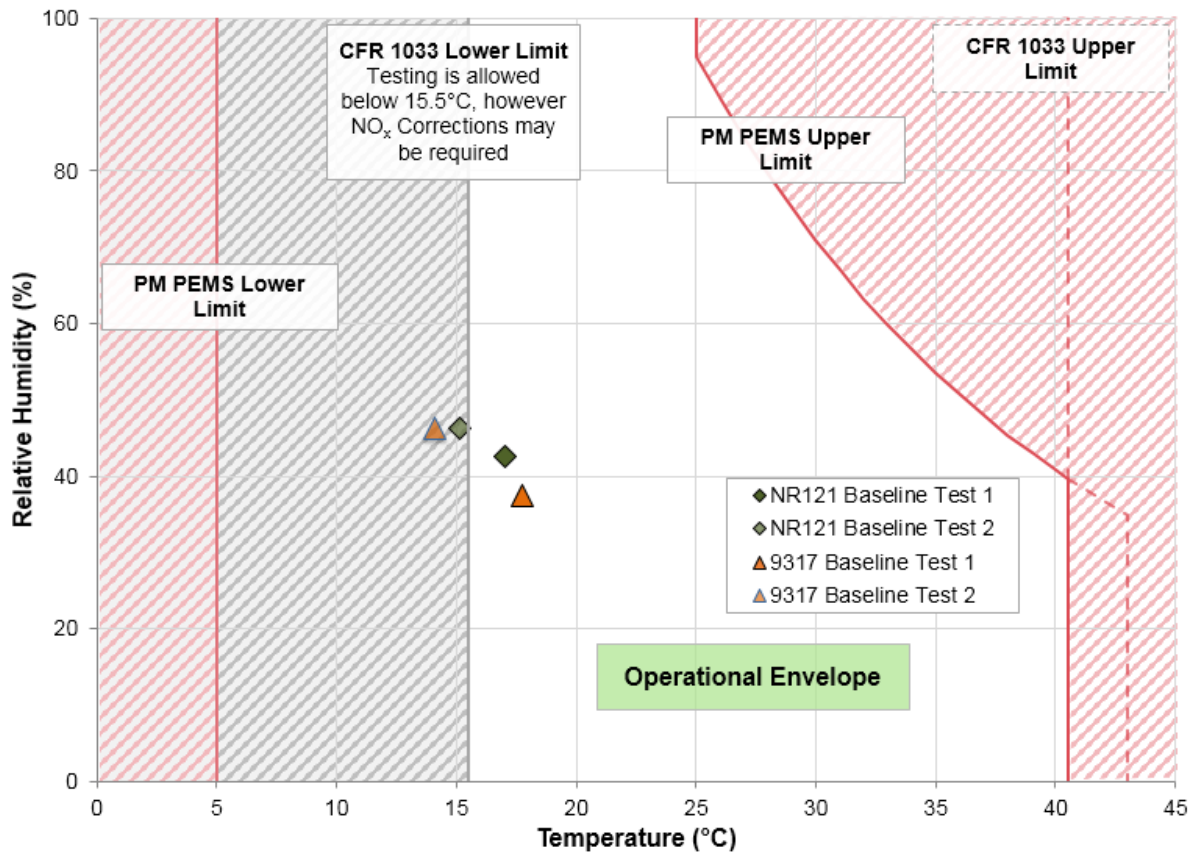

Figure 11 – Environmental Test Conditions

Comparison to Tier 0+ Emissions Limits

As shown in Table 8 below, the average cycle weighted emissions measured on both NR121 and 9317 were below the US EPA Tier 0+ limits for PM, THC, and CO. Further, the Baseline test results for both locomotives were lower than the more stringent Tier 3 limits for PM and CO.

These results demonstrate that the current engine configuration in each of these locomotives meets the Tier 0+ PM emission limit.

However, NOx emissions exceeded the US EPA Tier 0+ limits by 55% on NR 121 and 13% on 9317.

Emission	Tier 0+ Limits (g/kWh)	NR121 (g/kWh)	9317 (g/kWh)
PM	0.295	0.10	0.11
NO _x	10.7	16.6	12.1
THC	1.34	0.52	0.46
CO	6.71	1.09	1.19

Emission	% Difference to Tier 0+	
	NR121	9317
PM	-66%	-63%
NO _x	55%	13%
THC	-61%	-66%
CO	-84%	-82%

Table 8 – Emissions Results Compared to Tier 0+ Limits

Chart 4 compares measured Particulate matter (PM) and NO_x results from testing to Tier 0+ NO_x and PM limits.

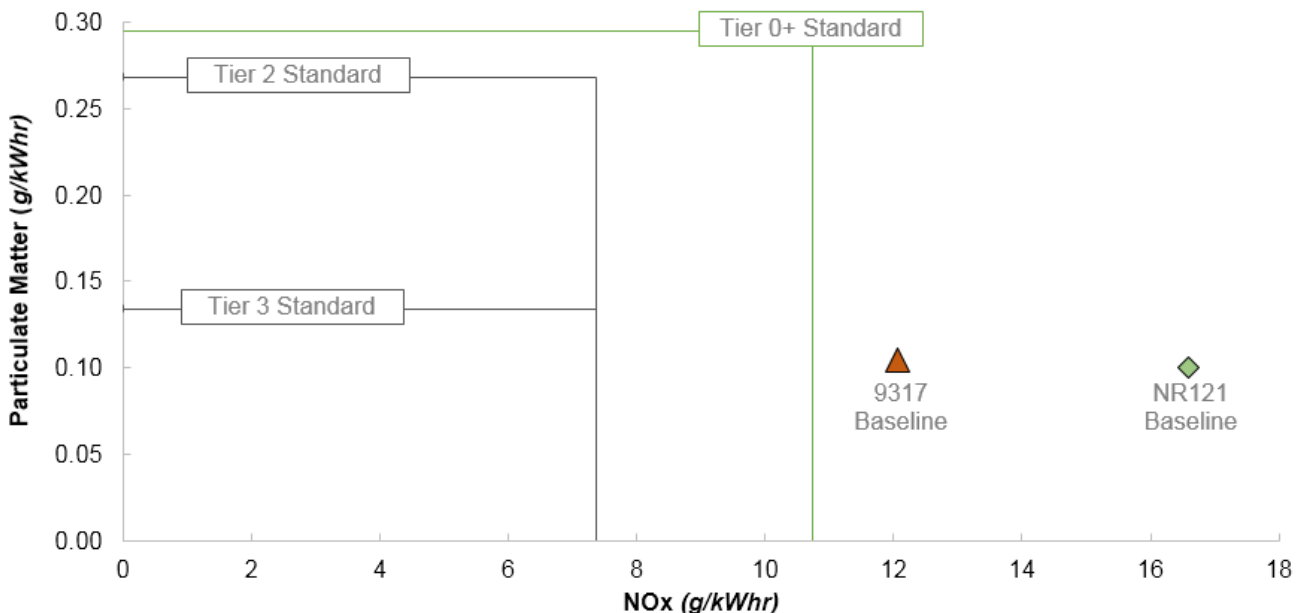

Chart 4 – Emissions Test Results Compared to Tier 0+ NOx and PM Limits

Cycle Weighted Results

This section presents the cycle weighted results of each baseline test (2 tests) for each locomotive.

appropriate to the locomotive type, as specified by the US EPA.

Cycle weighted average emission rates represent results from an averaged operating duty cycle,

NR121:

Figure 12 below shows the test to test repeatability achieved on this locomotive was excellent, with BSFC

at 0%, NO_x, CO₂ and THC results within 1%, and PM and CO within 5%.

	BSFC	PM	NO _x	CO ₂	CO	THC
Baseline Test 1	210	0.101	16.6	649	1.117	0.519
Baseline Test 2	209	0.096	16.5	648	1.057	0.513
% Difference	-0.0%	-4.5%	-0.5%	-0.2%	-5.3%	-1.0%
	BSFC (g/kW/hr)	PM (g/kW/hr)	NO _x (g/kW/hr)	CO ₂ (g/kW/hr)	CO (g/kW/hr)	THC (g/kW/hr)
NR121	BSFC	Exhaust Emissions				

Figure 12 – NR121 Cycle Weighted Test Results

9317:

The test to test repeatability achieved on this locomotive was excellent, with BSFC better than 1%,

NO_x, CO₂ and THC results within 2%, and PM and CO within 1%, as shown in Figure 13 below.

Figure 13 – 9317 Cycle Weighted Test Results

	BSFC	PM	NO _x	CO ₂	CO	THC
Baseline Test 1	213	0.107	12.2	662	1.194	0.464
Baseline Test 2	215	0.104	12.0	665	1.188	0.458
% Difference	0.7%	-2.9%	-1.2%	0.5%	-0.6%	-1.2%
	BSFC (g/kW/hr)	PM (g/kW/hr)	NO _x (g/kW/hr)	CO ₂ (g/kW/hr)	CO (g/kW/hr)	THC (g/kW/hr)
9317	BSFC	Exhaust Emissions				

Brake Specific Fuel Consumption

Brake Specific Fuel Consumption (BSFC) is an indicator of engine efficiency, with the units g/kWhr being: grams of fuel burned per unit of work.

BSFC was normalised according to AAR guidelines (refer Appendix D).

NR121:

The test to test repeatability of BSFC was excellent and was within 1% for all modes except mode one and two, where it was within 2% and 3% respectively.

Chart 5 presents the mode by mode results of BSFC for locomotive NR121.

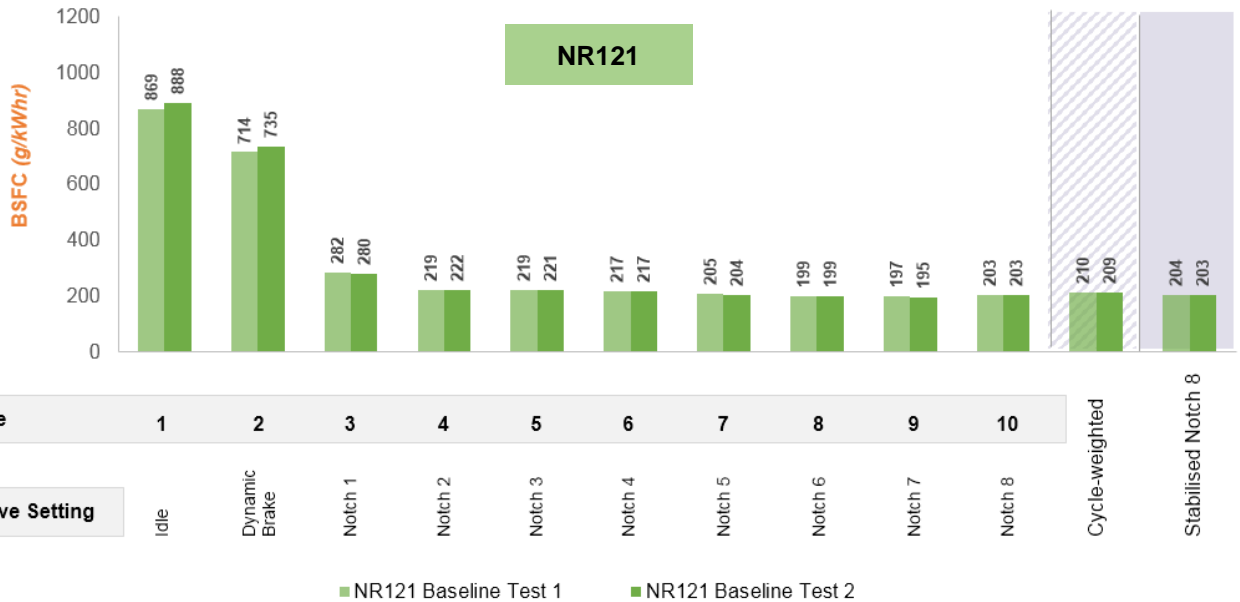

Chart 5 – NR121: Brake Specific Fuel Consumption Results

9317:

9317 operates a 'skip fire' function in Mode 2 (dynamic brake). Skip fire is a version of cylinder deactivation employed to improve fuel economy by alternating the cylinders that are fired when the engine is operating at a low load or fuel consumption condition.

The test to test repeatability of BSFC was excellent and was within 1% for most modes. Mode 1 BSFC was within 17%. Chart 6 presents the mode by mode results of BSFC for locomotive 9713.

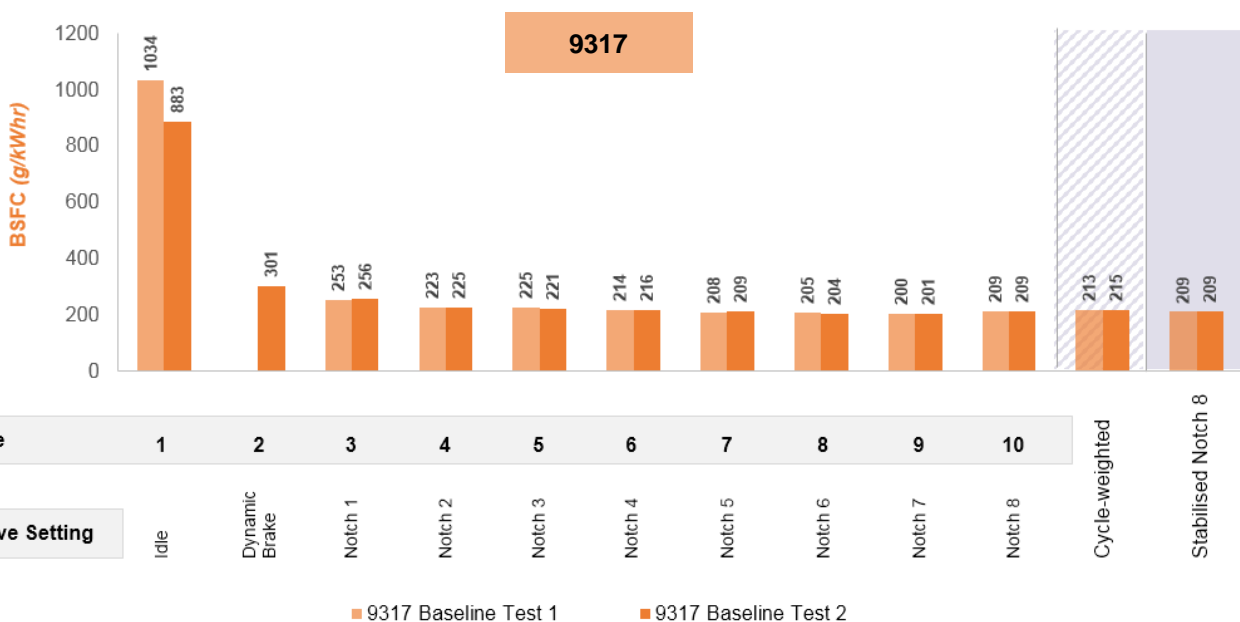

Chart 6 – 9317: Brake Specific Fuel Consumption Results

Emissions – Brake Specific PM

Often visible as soot and smoke ejected from an exhaust, particulate matter (PM) is a complex mixture

of small solid and liquid particles suspended in the exhaust gas.

NR121:

Brake specific PM emissions were significantly higher at Mode 1 (idle) and at Mode 2 (dynamic brake) than at any other mode as seen in Chart 7 below.

Test to test repeatability was very good. The cycle weighted PM emissions were within Tier 0+ limits.

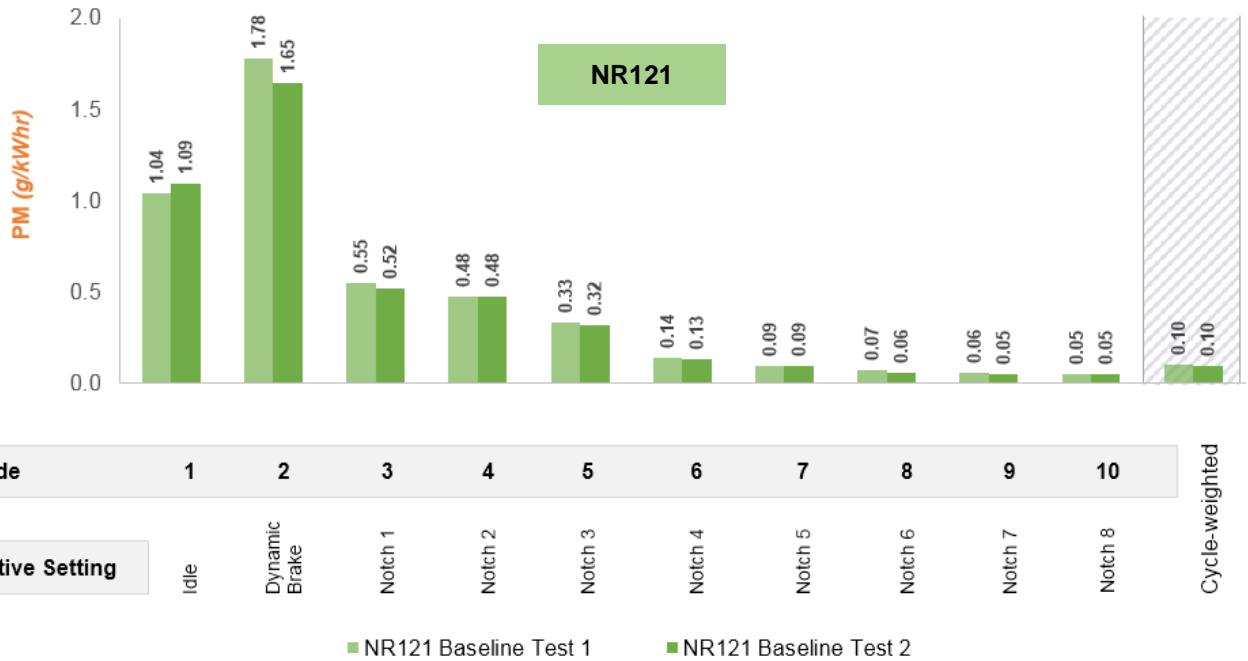

Chart 7 – NR121: PM Emission Results

9317:

Brake specific PM emissions were significantly higher at idle (Mode 1) than at any other mode, as seen in Chart 8 below.

Test to test repeatability was generally very good and the cycle weighted PM emissions were within Tier 0+ limits.

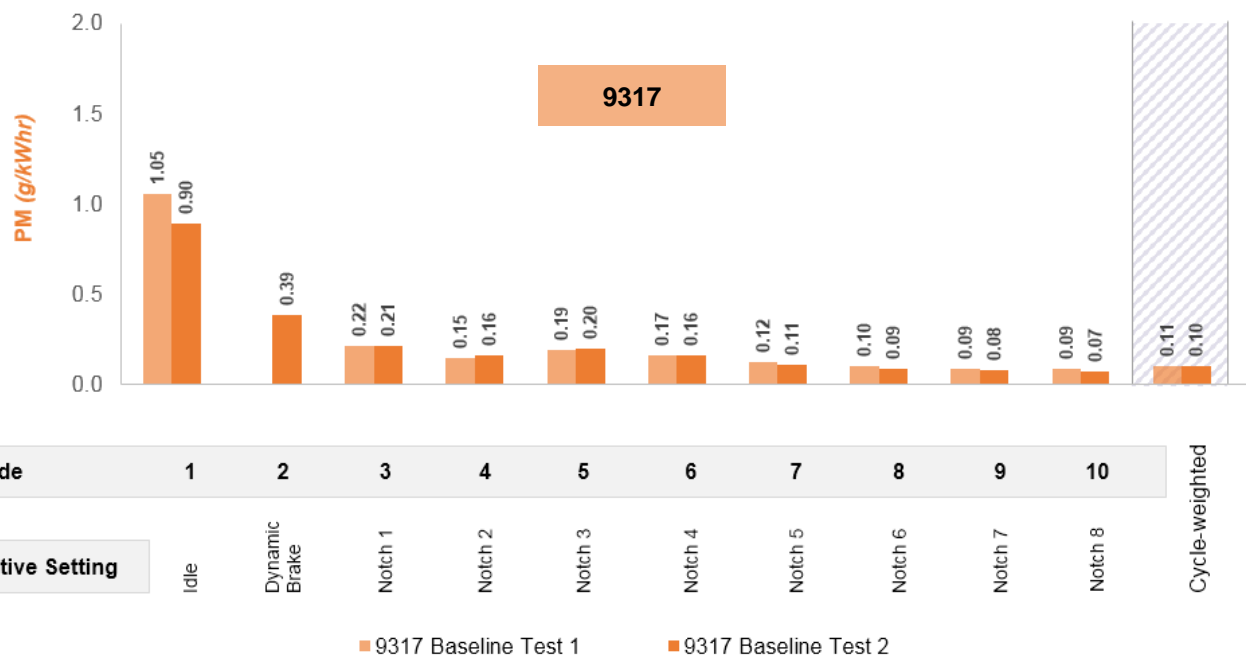

Chart 8 – 9317: PM Emission Results

Emissions – Brake Specific NO_x

Oxides of nitrogen (NO_x), is the sum of nitric oxide (NO) and nitrogen dioxide (NO₂).

NR121:

The cycle weighted NO_x emissions were 55% higher than the Tier 0+ limits.

The test to test repeatability was very good across all modes (within 3%) and 1% or better between tests on six modes as seen in Chart 9 below.

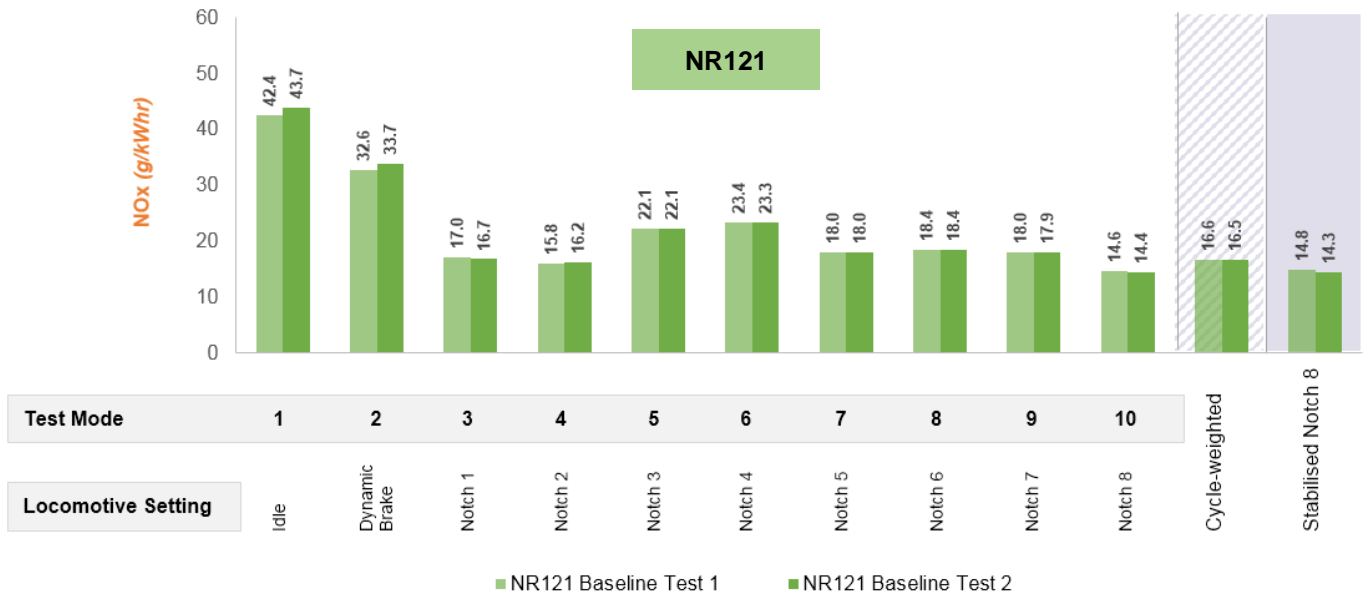

Chart 9 – NR121: NO_x Emissions Results

9317:

The cycle weighted NO_x emissions were 13% higher than the Tier 0+ limits. The test to test repeatability was very good across all modes (within 2%) with the

exception of Mode 1 (idle) that was within 16% as seen in Chart 10 below.

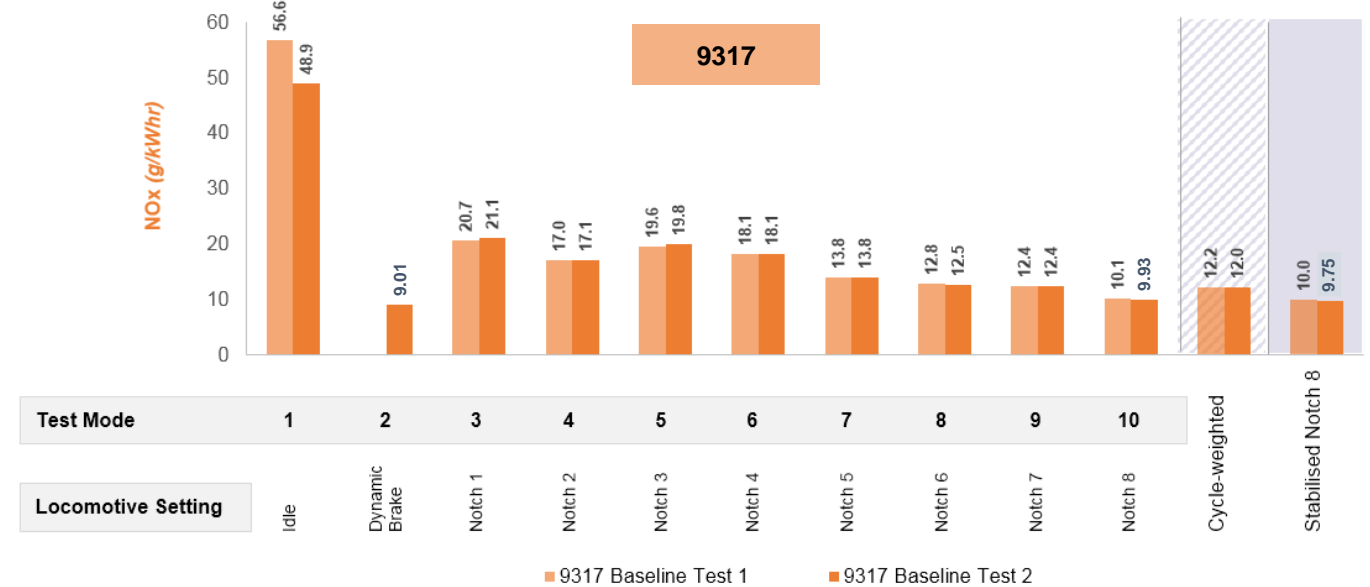

Chart 10 – 9317: NO_x Emissions Results

Emissions – Brake Specific CO₂

Carbon Dioxide (CO₂) is not regulated by the US EPA locomotive emission standards, however it is

presented in this report due to its contribution to greenhouse gas emissions.

NR121:

Brake specific CO₂ emissions were significantly higher at Mode 1 (idle) and Mode 2 (dynamic brake) than at any other mode.

Test to test variation of results was very small as seen in Chart 11 below.

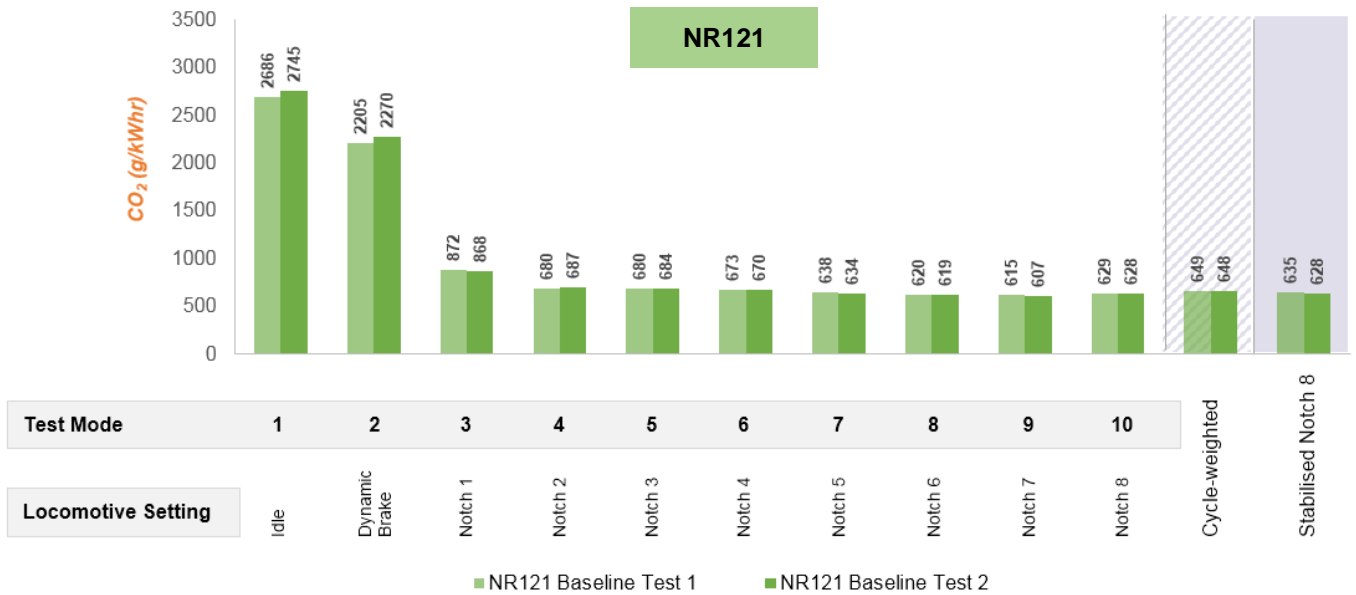

Chart 11 – NR121: CO₂ Emissions Results

9317:

Brake specific CO₂ emissions were significantly higher at Mode 1 (idle) than at all other modes. Skip fire function operates in dynamic brake.

Test to test variation was very small, with the exception of Mode 1 (idle) that was within 18%. Chart 12 below presents the mode by mode results of each test.

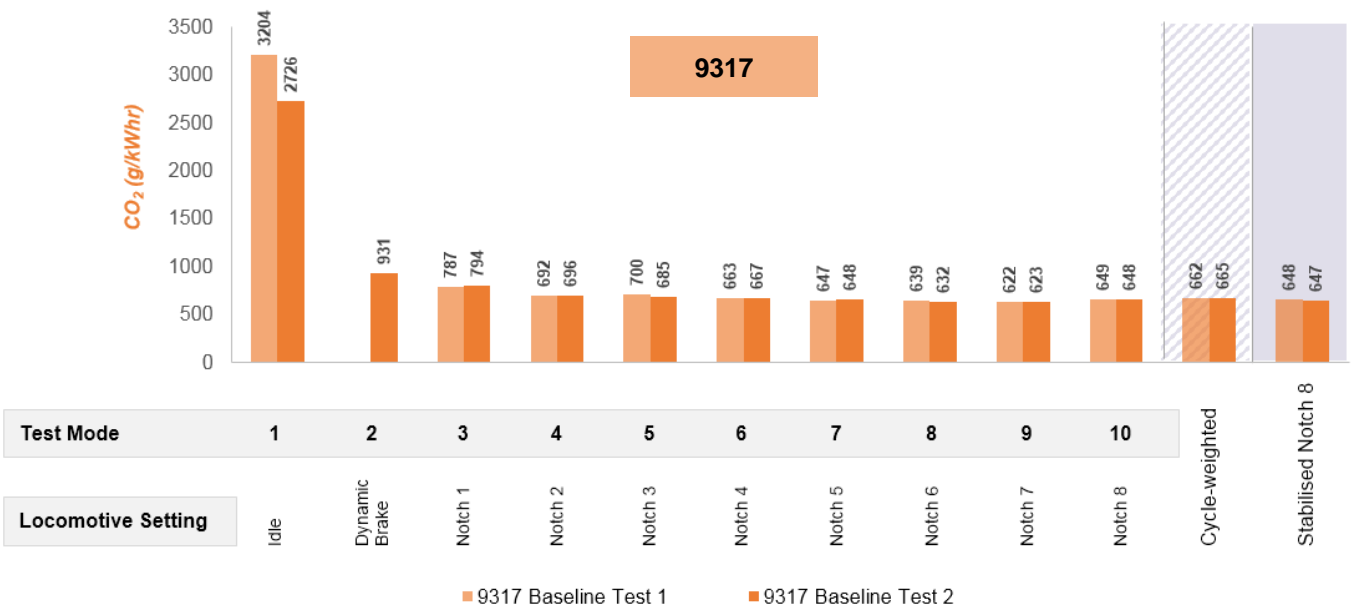

Chart 12 – 9317: CO₂ Emissions Results

Emissions – Brake Specific CO

CO is carbon monoxide and is produced due to insufficient oxygen during combustion.

NR121:

The average cycle weighted CO emissions were more than 80% below the Tier 0+ limits.

CO brake specific emissions were significantly higher at Mode 1 (idle) and Mode 2 (dynamic brake) than at any other mode, as seen in Chart 13 below.

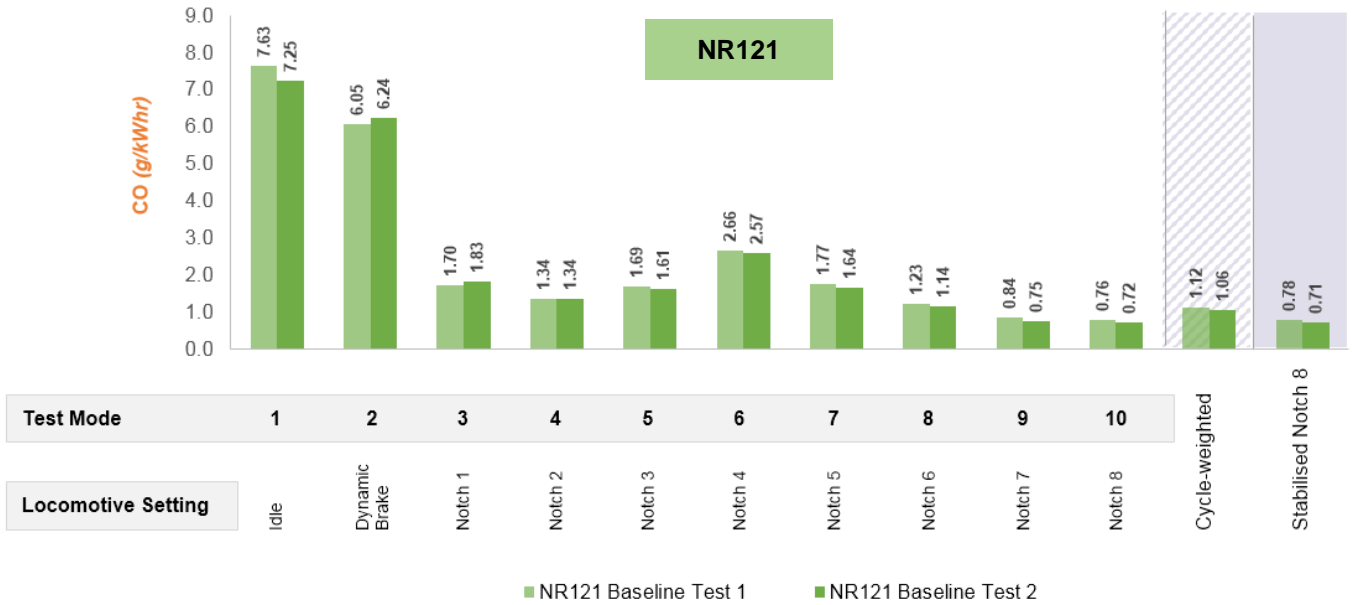

Chart 13 – NR121: CO Emissions Results

9317:

The average cycle weighted CO emissions were more than 80% below the Tier 0+ limits.

CO brake specific emissions were significantly higher at Mode 1 (idle) than at any other mode, as seen in Chart 14 below.

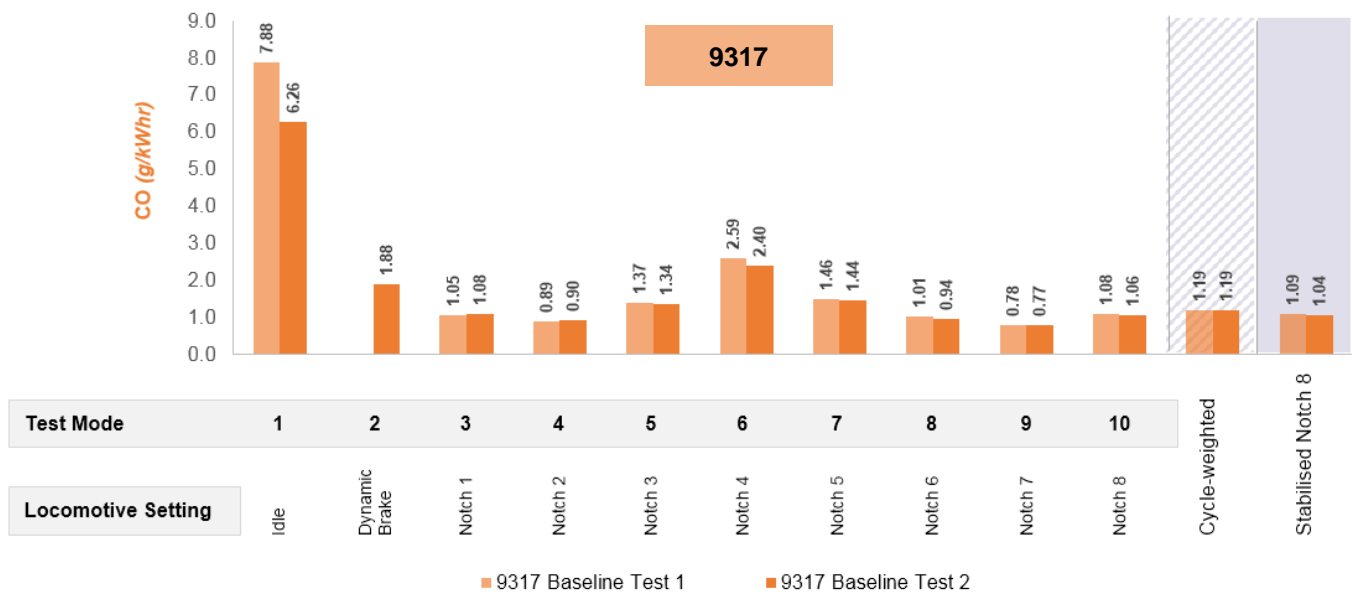

Chart 14 – 9317: CO Emissions Results

Emissions – Brake Specific THC

Total hydrocarbons (THC) represents unburnt and partially burnt fuel.

NR121:

Cycle weighted THC emissions were below the Tier 0+ limit of 1.34 g/kW/hr.

THC brake specific emissions were significantly higher at Mode 1 (idle) and Mode 2 (dynamic brake) than at any other mode.

Test to test repeatability was very good and is shown in Chart 15 below.

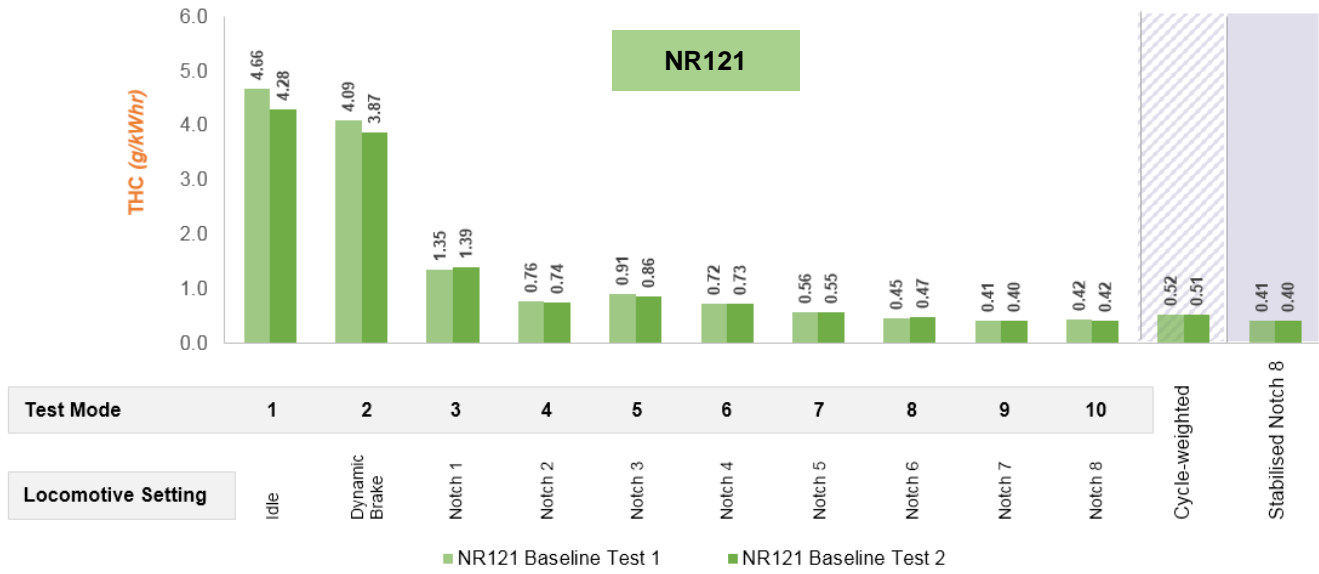

Chart 15 – NR121: THC Emissions Results

9317:

Cycle weighted THC emissions were below the Tier 0+ limit of 1.34 g/kW/hr.

THC brake specific emissions were significantly higher at Mode 1 (idle) than at any other mode.

Test to test repeatability was very good and can be seen in Chart 16 below.

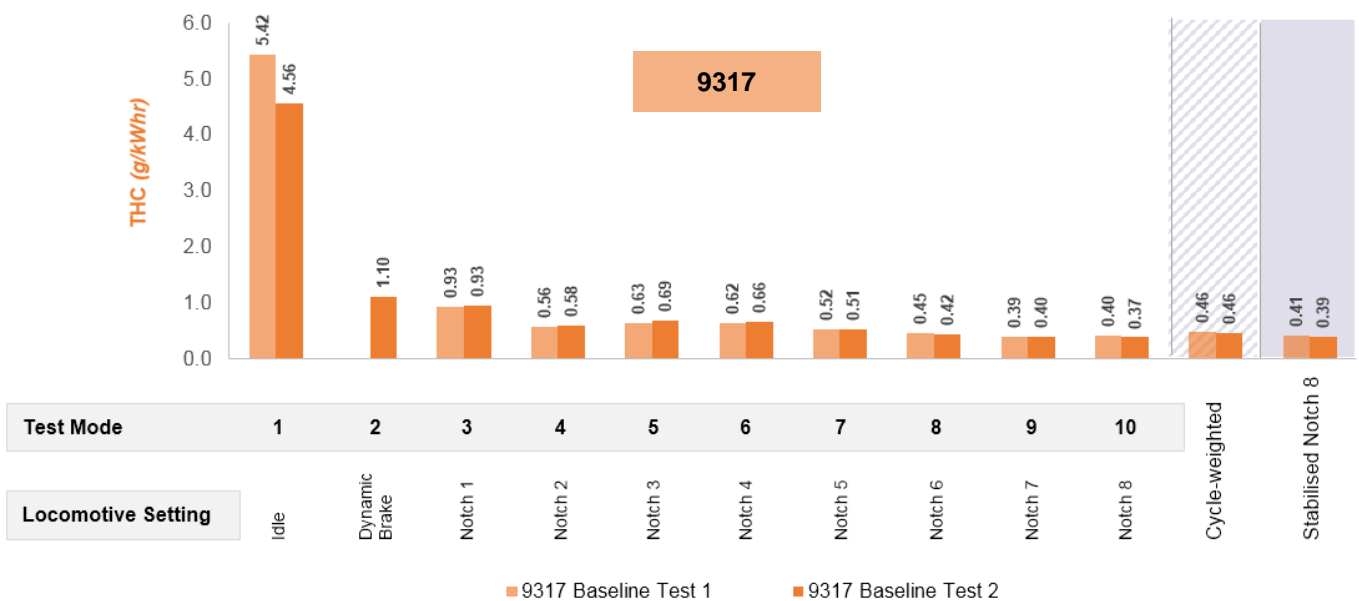

Chart 16 – 9317: THC Emissions Results

Operating Temperature – Exhaust

Exhaust temperature was measured in the exhaust stack extension with the thermocouple placed

between the gaseous and particulate matter sampling probes.

NR121:

Exhaust gas temperature was recorded for all modes. No issues were observed and the results are presented in Chart 17.

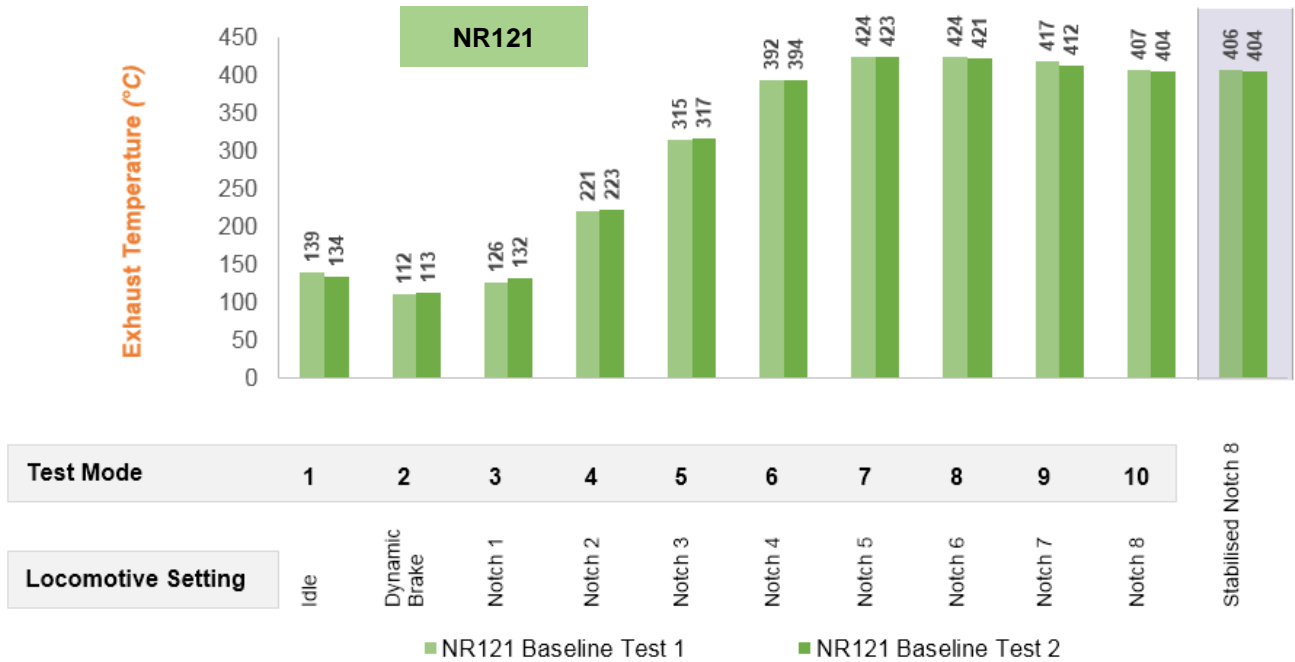

Chart 17 – NR121: Exhaust Temperature

9317:

Exhaust gas temperature was recorded for all modes. No issues were observed and the results are presented in Chart 18.

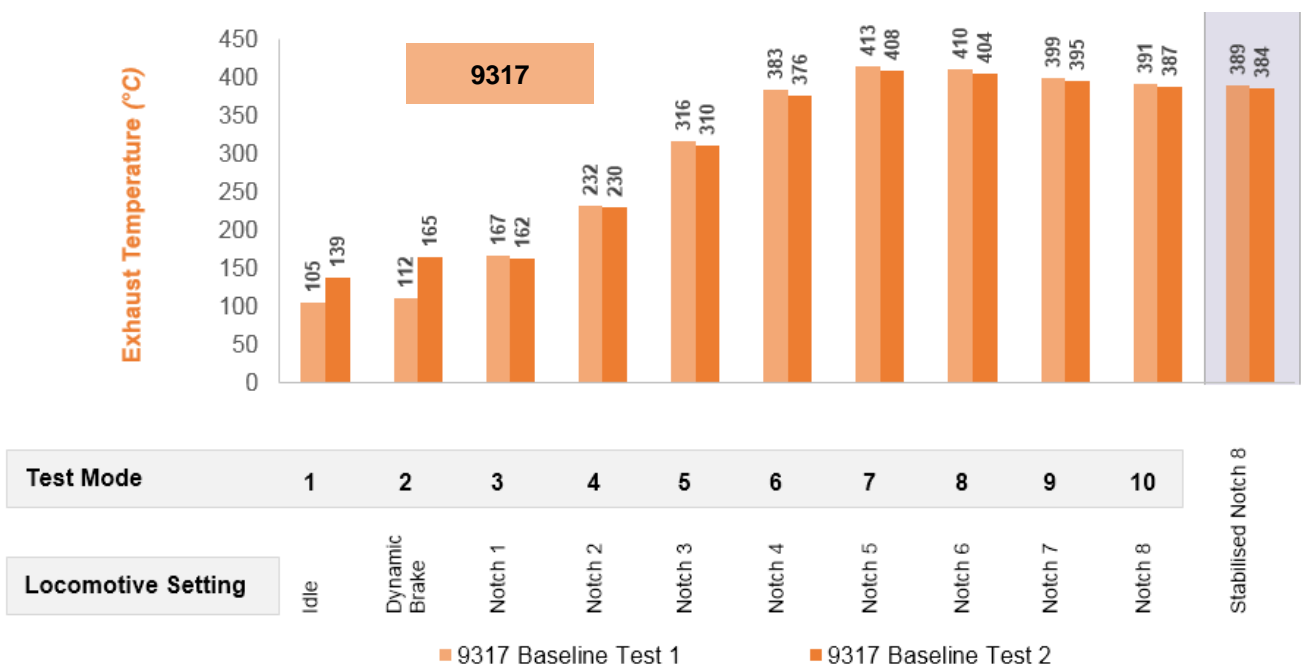

Chart 18 – 9317: Exhaust Temperature

Operating Temperature – Charge Air

Charge air temperature was measured in the air intake manifold on the right-hand bank towards the generator.

NR121:

Charge air temperature was recorded for all modes. No issues were observed and the results are presented in Chart 19.

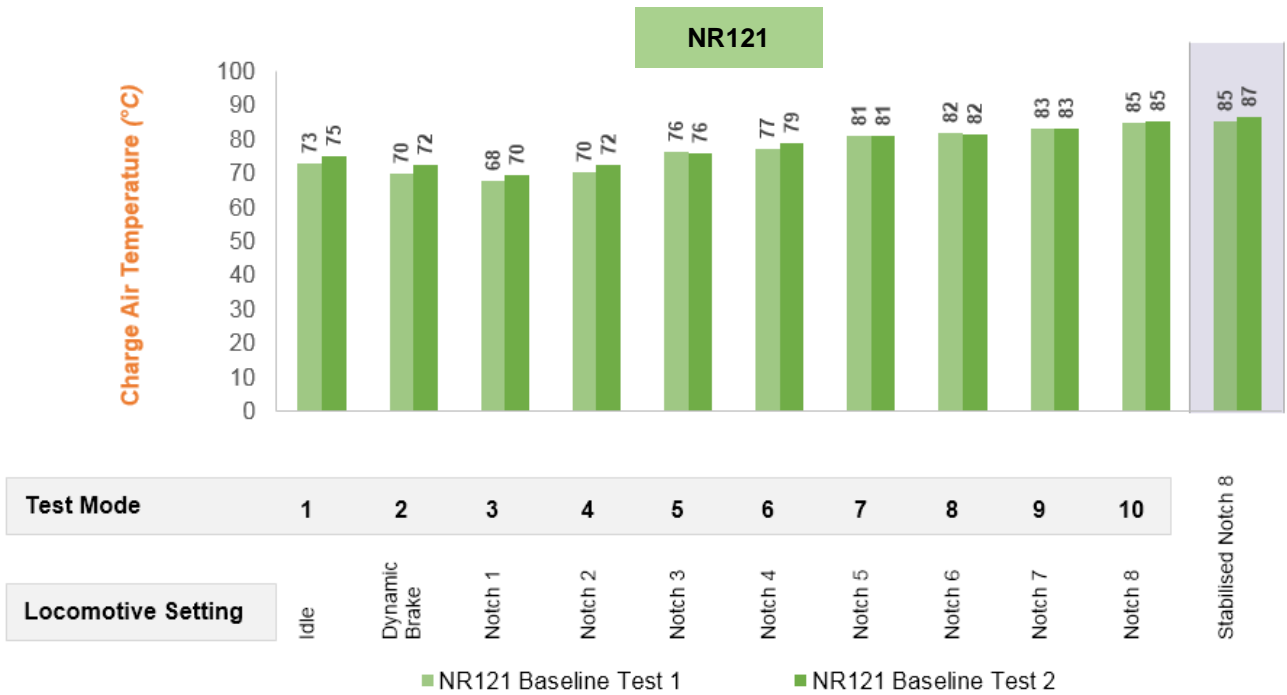

Chart 19 – NR121: Charge Air Temperature

9317:

Charge air temperature was recorded for all modes. No issues were observed and the results are presented in Chart 20.

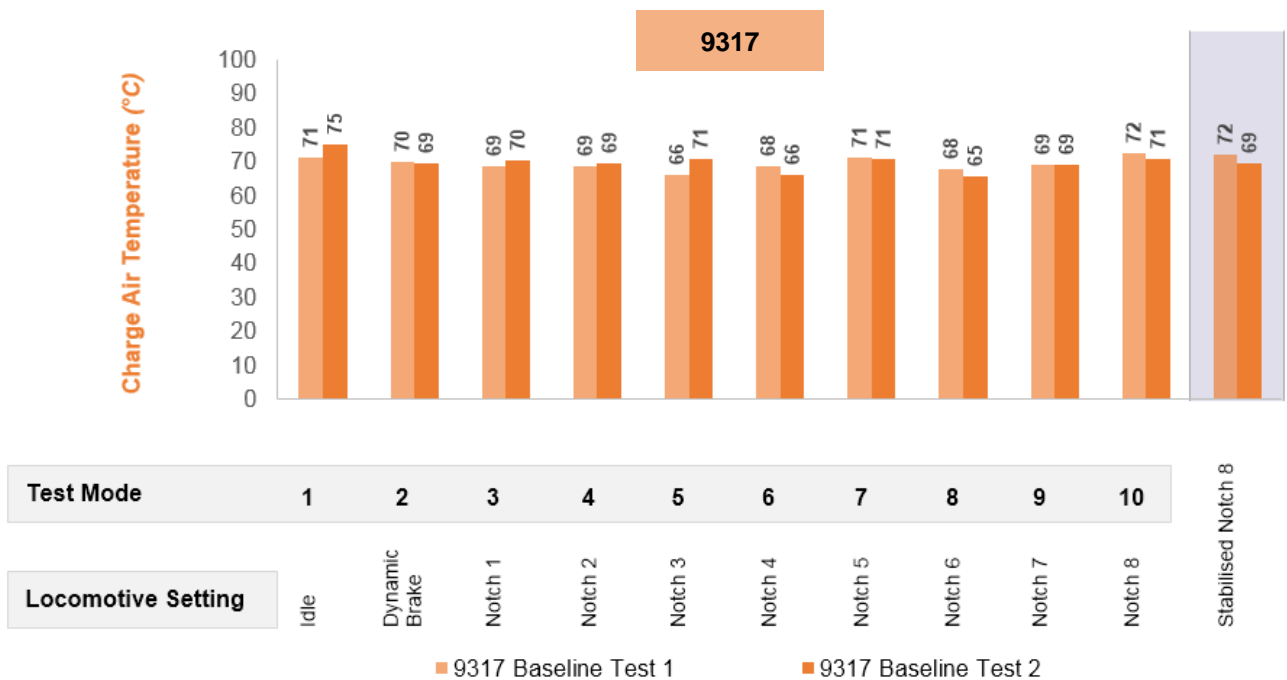

Chart 20 – 9317: Charge Air Temperature

Operating Temperature – Engine Oil

Engine oil temperature was measured on the left-hand side of the engine.

NR121:

Engine oil temperature was recorded for all modes. No issues were observed and the results are presented in Chart 21.

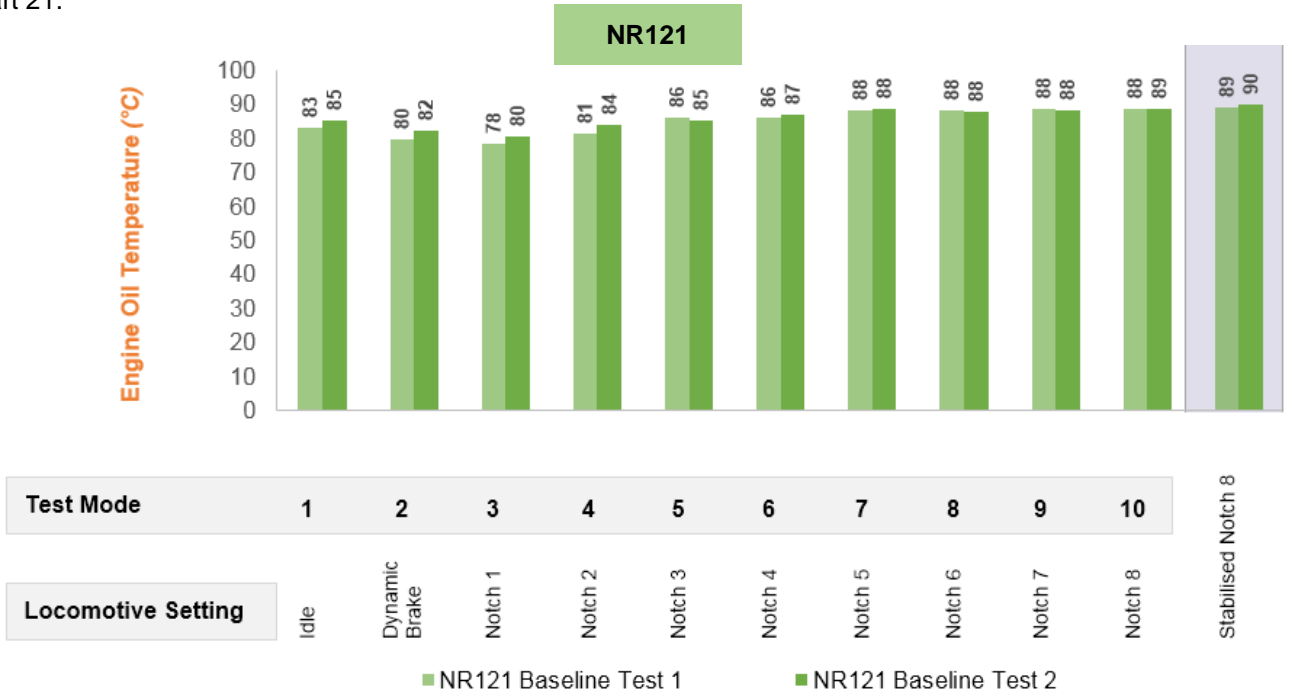

Chart 21 – NR121: Engine Oil Temperature

9317:

Engine oil temperature was recorded for all modes. No issues were observed and the results are presented in Chart 22.

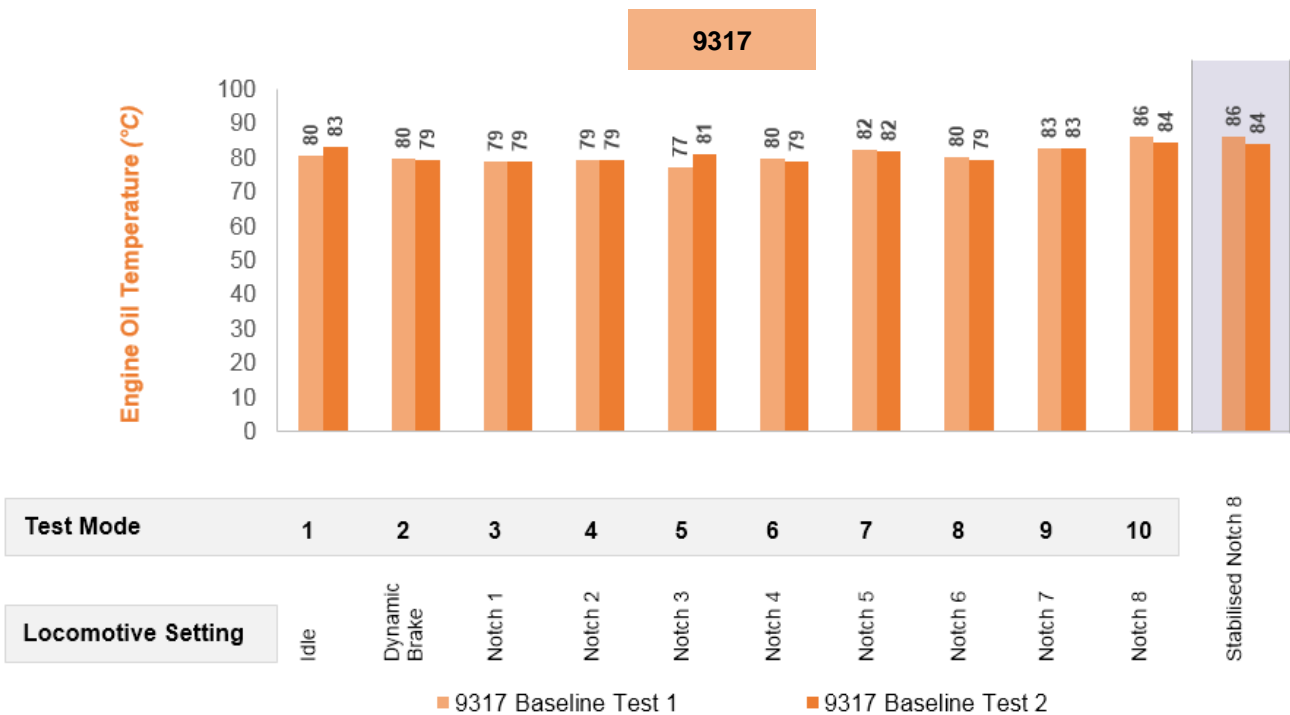

Chart 22 – 9317: Engine Oil Temperature



APPENDICES

A. SUMMARY RESULTS 42

B. CORRECTION FACTORS 43

C. VARIATIONS TO CFR 40 1065 44

D. BSFC CORRECTIONS 45

E. PEMS OVERVIEW 46

A. SUMMARY RESULTS

Emissions and fuel consumption summary data from all tests.

NR121 Baseline Average													
Description	Unit	Mode 1	Mode 2	Mode 3	Mode 4	Mode 5	Mode 6	Mode 7	Mode 8	Mode 9	Mode 10	Cycle Weighted	Stabilised Notch 8
CO2	g/kWhr	2716	2238	870	683	682	671	636	619	611	629	649	632
CO	g/kWhr	7.44	6.15	1.77	1.34	1.65	2.62	1.70	1.18	0.80	0.74	1.09	0.75
THC	g/kWhr	4.47	3.98	1.37	0.75	0.88	0.72	0.56	0.46	0.41	0.42	0.52	0.41
NOx	g/kWhr	43.0	33.1	16.8	16.0	22.1	23.3	18.0	18.4	17.9	14.5	16.6	14.5
PM	g/kWhr	1.07	1.71	0.53	0.48	0.33	0.14	0.09	0.07	0.06	0.05	0.10	NA
BSFC	g/kWhr	879	724	281	221	220	217	205	199	196	203	210	203

NR121 Baseline Test 1													
Description	Unit	Mode 1	Mode 2	Mode 3	Mode 4	Mode 5	Mode 6	Mode 7	Mode 8	Mode 9	Mode 10	Cycle Weighted	Stabilised Notch 8
CO2	g/kWhr	2686	2205	872	680	680	673	638	620	615	629	649	635
CO	g/kWhr	7.63	6.05	1.70	1.34	1.69	2.66	1.77	1.23	0.84	0.763	1.12	0.78
THC	g/kWhr	4.66	4.09	1.35	0.76	0.91	0.72	0.56	0.45	0.41	0.42	0.52	0.41
NOx	g/kWhr	42.4	32.6	17.0	15.8	22.1	23.4	18.0	18.4	18.0	14.6	16.6	14.8
PM	g/kWhr	1.04	1.78	0.55	0.48	0.33	0.14	0.09	0.07	0.06	0.05	0.10	NA
BSFC	g/kWhr	869	714	282	219	219	217	205	199	197	203	210	204

NR121 Baseline Test 2													
Description	Unit	Mode 1	Mode 2	Mode 3	Mode 4	Mode 5	Mode 6	Mode 7	Mode 8	Mode 9	Mode 10	Cycle Weighted	Stabilised Notch 8
CO2	g/kWhr	2745	2270	868	687	684	670	634	619	607	628	648	628
CO	g/kWhr	7.25	6.24	1.83	1.34	1.61	2.57	1.64	1.14	0.75	0.72	1.06	0.71
THC	g/kWhr	4.28	3.87	1.39	0.74	0.86	0.73	0.55	0.47	0.40	0.42	0.51	0.40
NOx	g/kWhr	43.7	33.7	16.7	16.2	22.1	23.3	18.0	18.4	17.9	14.4	16.5	14.3
PM	g/kWhr	1.09	1.65	0.52	0.48	0.32	0.13	0.09	0.06	0.05	0.05	0.10	NA
BSFC	g/kWhr	888	735	280	222	221	217	204	199	195	203	209	203

9317 Baseline Average													
Description	Unit	Mode 1	Mode 2	Mode 3	Mode 4	Mode 5	Mode 6	Mode 7	Mode 8	Mode 9	Mode 10	Cycle Weighted	Stabilised Notch 8
CO2	g/kWhr	2965	931	790	694	692	665	648	635	623	648	663	647
CO	g/kWhr	7.07	1.88	1.07	0.90	1.36	2.49	1.45	0.97	0.78	1.07	1.19	1.07
THC	g/kWhr	4.99	0.55	0.93	0.57	0.66	0.64	0.52	0.44	0.39	0.39	0.46	0.40
NOx	g/kWhr	52.8	9.01	20.9	17.0	19.7	18.1	13.8	12.6	12.4	10.0	12.1	9.85
PM	g/kWhr	0.97	0.39	0.22	0.16	0.19	0.16	0.12	0.10	0.09	0.08	0.11	NA
BSFC	g/kWhr	959	301	255	224	223	215	209	205	200	209	214	209

9317 Baseline Test 1													
Description	Unit	Mode 1	Mode 2	Mode 3	Mode 4	Mode 5	Mode 6	Mode 7	Mode 8	Mode 9	Mode 10	Cycle Weighted	Stabilised Notch 8
CO2	g/kWhr	3204	0	787	692	700	663	647	639	622	649	662	648
CO	g/kWhr	7.88	0	1.05	0.89	1.37	2.59	1.46	1.01	0.78	1.08	1.19	1.09
THC	g/kWhr	5.42	0	0.93	0.56	0.63	0.62	0.52	0.45	0.39	0.40	0.46	0.41
NOx	g/kWhr	56.6	0	20.7	17.0	19.6	18.1	13.8	12.8	12.4	10.1	12.2	10.0
PM	g/kWhr	1.05	0	0.22	0.15	0.19	0.17	0.12	0.10	0.09	0.09	0.11	NA
BSFC	g/kWhr	1034	0	253	223	225	214	208	205	200	209	213	209

9317 Baseline Test 2													
Description	Unit	Mode 1	Mode 2	Mode 3	Mode 4	Mode 5	Mode 6	Mode 7	Mode 8	Mode 9	Mode 10	Cycle Weighted	Stabilised Notch 8
CO2	g/kWhr	2726	931	794	696	685	667	648	632	623	648	665	647
CO	g/kWhr	6.26	1.88	1.08	0.90	1.34	2.40	1.44	0.94	0.77	1.06	1.19	1.04
THC	g/kWhr	4.56	1.10	0.93	0.58	0.69	0.66	0.51	0.42	0.40	0.37	0.46	0.39
NOx	g/kWhr	48.9	9.01	21.1	17.1	19.8	18.1	13.8	12.5	12.4	9.93	12.0	9.75
PM	g/kWhr	0.90	0.39	0.21	0.16	0.20	0.16	0.11	0.09	0.08	0.07	0.10	NA
BSFC	g/kWhr	883	301	256	225	221	216	209	204	201	209	215	209

Table 9 - Summary of Results

B. CORRECTION FACTORS

This section outlines key calculations and correction factors applied to measurement values that have not been specified elsewhere within this report.

- No thermophoresis particulate loss correction has been applied.
- Dry/Wet correction of raw emission concentrations have been performed as per ISO 16183.
- Brake Specific Fuel Consumption was corrected according to equations in Appendix D.
- Fuel properties applied for calculations and data analysis are shown in Table 20.
- Fuel consumption corrected for density and calorific value for each test. Test results of fuel sample analysis are shown in Table 11.

Post Processor Fuel Properties				
H:C	1.86		Mass fraction H	13.30
C:C	1.00		Mass fraction C	86.60
S:C	0.0		Mass fraction S	0.0
N:C	0.0		Mass fraction N	0.0
O:C	0.0		Mass fraction O	0.0

Table 10 – Post Processing Fuel Properties

NR121		Density	Calorific Value
		kg/L @ 15°C	MJ/kg
Baseline Test 1	Sample 1	0.8351	45.750
Baseline Test 2	Sample 1	0.8351	45.750

9317		Density	Calorific Value
		kg/L @ 15°C	MJ/kg
Baseline Test 1	Sample 1	0.8342	45.765
Baseline Test 2	Sample 1	0.8342	45.765

Table 11 – Fuel Test Results

C.VARIATIONS TO CFR 40 1065

Testing and data analysis complied with 40 CFR Part 1065 except for the following variations:

Item	CFR Specification	Variation
PM Dilution Ratio	Proportional	Constant dilution ratio of 5 applied
PM Filter Face Velocity	50 cm/s to 100 cm/s	Lower velocity
PM PEMS	40 CFR Part 1065 equipment specification	The PM PEM system is designed to exceed all of the latest in-field test requirements of CFR 1065 subpart J and meets the accuracy requirements of 1065 engine emissions testing.
Dry/Wet Emissions Corrections	40 CFR 1065.650 - Emission Calculations	ISO 16183 was used instead 1065.650

Table 12 – Variations to 40 CFR Part 1065

D. BSFC CORRECTIONS

Fuel flow was measured by a single Coriolis mass flow meter.

1. Fuel mass flow rate is measured as FR_{raw} in litres per hour
2. Fuel rate is corrected to 15.0 °C and according to the fuel meter calibration factors, applied internally within the fuel measurement module
3. Observed power is taken as measured shaft power (with calculations performed by GE); BHP_{obs}
4. Power air temperature correction factor a is calculated as:

$$a = -0.0004830508 \times \text{Ambient Temp } (^{\circ}\text{F}) + 1.028983051$$

5. Power atmospheric pressure correction factor b is calculated as:

$$b = 0.0023141891 \times P_{atmosphere} (\text{"Hg}) + 0.93321251$$

6. Fuel HHV correction factor z is calculated as:

$$z = \frac{HHV_{Test\ Fuel}}{HHV_{Reference\ Fuel}}$$

where the $HHV_{Reference\ Fuel}$ is taken as 19350 BTU/lb (45.008 MJ/kg)

7. Brake specific fuel consumption, corrected for all factors is calculated as:

$$BSFC_{Corr} = \frac{FR_{Net} \times z}{\left(\frac{BHP_{obs}}{a \cdot b} \right)} = \frac{FR_{Net}}{(BHP_{obs})} \cdot a \cdot b \cdot z$$

E. PEMS OVERVIEW

The AVL Gaseous PEMS meets instrumentation requirements for laboratory testing as specified in 40 CFR Part 1065 subpart C, as well as in-field testing requirements of 40 CFR 1065 subpart J.

The AVL PM PEMS meets the latest in-field test requirements of 40 CFR 1065 subpart J and meets the

Gas PEMS

All analysers are mounted inside temperature controlled enclosures to ensure stable conditions and a high accuracy even at changing ambient conditions. Exhaust gas flows at a rate of approximately 3.5 L/min through the 191°C temperature controlled sample line to the analysers. This prevents unaccountable losses of HC and NO₂ through condensation forming in the sample line. For each stage of testing, ABMARC used the same span gases to ensure repeatability was achieved across gaseous emissions.

accuracy requirements for laboratory testing specified in 40 CFR 1065.

The PM PEMS System allows time resolved (second by second) PM emissions data from its real-time photo acoustic sensor measurement in conjunction with the gravimetric filter PM mass.

PM PEMS

The Gravimetric Filter Module provides the dilution air and draws the diluted exhaust gas from the dilution cell, mounted just after the sample probe, through a PM Filter and to the photo-acoustic measurement cell, providing time resolved (second by second) data. The device offers the choice between constant or proportional dilution. A constant dilution ratio of 5 was used for all testing. Ambient air is dried with a water separator and cleaned with a HEPA and carbon filters for dilution air, to remove any contaminants.

Attribute	CFR 40 Part 1065 requirement		AVL PEMS & Fuel Flowmeter	
	Accuracy	Repeatability	Accuracy	Repeatability
Fuel flow	± 2% pt	± 1% pt	± 0.1%	± 0.06%
	± 1.5% of max	± 0.75% of max		
CO/CO ₂	± 2%	± 1%	± 2%	± 1%
Hydrocarbons	± 2%	± 1%	± 2%	± 0.5%
NOx (NO ₂ /NO)	± 2%	± 1%	± 2%	± 0.5%
PM (Gravimetric)	See 1065.790 / 2%	0.5 micro grams / 1%	Satisfied	Satisfied

Gas Analyser Drift Specifications

THC: Heated FID <1.5ppmC/8hrs
 NO/NO₂: NDUV 2ppm/8hrs
 CO: NDIR 20ppm/8hrs
 CO₂: NDIR 0.1 vol.%/8hrs

PM Analyser Specifications

Raw sample rate: 6 LPM over filter.
 Face velocity: 45cm/sec
 PM Filters: 47mm TX40



Gas PEMS Module



Photo-acoustic sensor

Gravimetric Filter Module

PM PEMS Modules

PEMS are used for US EPA heavy-duty in-use testing (HDIUT), in-service conformity testing (ISC) and during the development of engines and exhaust after treatment systems.

The combination of two PM measurement principles (gravimetric and photo-acoustic) were developed to meet US and EU in-use requirements for time resolved

Gas Analysers

Heated Flame Ionisation Detector (FID)

The AVL Gas PEMS uses a heated FID analyzer for measuring the THC concentrations.

The flame ionization detector measures hydrocarbons through the ionization of carbon atoms in organic compounds when burned in a hydrogen flame. A supply of burner air free of hydrocarbons maintains the flame. Ionized particles are produced using the hydrogen flame to burn hydrocarbons present in the sample gas. This generates an ionization current between the two electrode shells that is directly proportional to the number of organically bound carbon atoms present within the sample gas. This ionization current is amplified electrically and converted into a calibrated voltage signal for data acquisition.

Ultra Violet (UV)

The NO and NO₂ measurement is conducted simultaneously and directly (without the need of a NO₂ to NO converter) using the UV analyzer. The UV Analyser is a dual-component UV photometer with high zero-point and end-point stability. The system reads NO and NO₂ separately, which are then combined to provide NO_x readings.

Non-Dispersive Infra-Red (NDIR)

CO and CO₂ measurements are conducted with the NDIR analyser, specially optimized for high accuracy and resolution of the CO channel at low concentrations. Qualitative and quantitative molecular analysis is performed by infrared spectrometry. The analyser is located in a temperature controlled (± 0.5 °C) compartment that is maintained even during rapid changes in ambient temperature. Under these conditions, the NDIR provides stable signals with little to no drift over hours of operation.



Heated Gas Transfer Line

measurements. Gravimetric measurement delivers a single value for an entire test. The time-resolved particulate (PM) emissions are calculated by weighing the loaded gravimetric filter after the end of the test and using the time resolved soot signal and the exhaust mass flow as inputs. This enables second by second PM data to be captured during testing.

PM Analysers

PM Dilution Cell and Transfer Line

The dilution and exhaust transfer unit consists of the dilution cell at the sample probe, which receives a dilution air supply via an external hose from the Gravimetric Filter Module (GFM). The dilution cell feeds directly into the 52 °C heated transfer tube connected to the GFM.

A dilution ratio of 5 was used for all tests.

Photo-Acoustic Sensor

The flow rate through the photo-acoustic sensor is approximately 2L/min. Time resolved PM emissions are determined by scaling the real-time soot signal to the gravimetric filter reference. The exhaust sample is exposed to modulated light which is absorbed by the soot particles in the exhaust causing periodic warming and cooling of the particles. The resulting expansion and contraction of the carrier gas generates a sound wave that is detected by microphones. Clean air produces no signal. When the air is loaded with soot or exhaust gas, the signal rises proportionally to the concentration of soot in the measurement volume. The soot sensor does not respond to the volatile fractions of the PM.

Gravimetric Filter Module

Filter loading on the PM filter is monitored to avoid overloading. High-performance filter elements are used for filtering particulates. A filter efficiency of 99.995% is specified for filter elements at the nominal flow rate of 5 L/min through the filter.

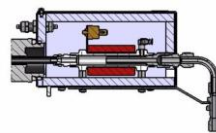

PM Dilution Cell



PM and Gas PEMS set up prior to the locomotive arriving



Diesel Locomotive – Fuel Efficiency and Emissions Testing

ABMARC

ADDRESS

ABMARC
7/51 Kalman Dr
Boronia, Vic 3155

GENERAL ENQUIRIES

P + 61 3 9729 5129
E info@abmarc.com.au
www.abmarc.com.au